

Water Resources and Environmental Geology of Sable Island, Nova Scotia

By T. W. Hennigar

Report No. 76-1

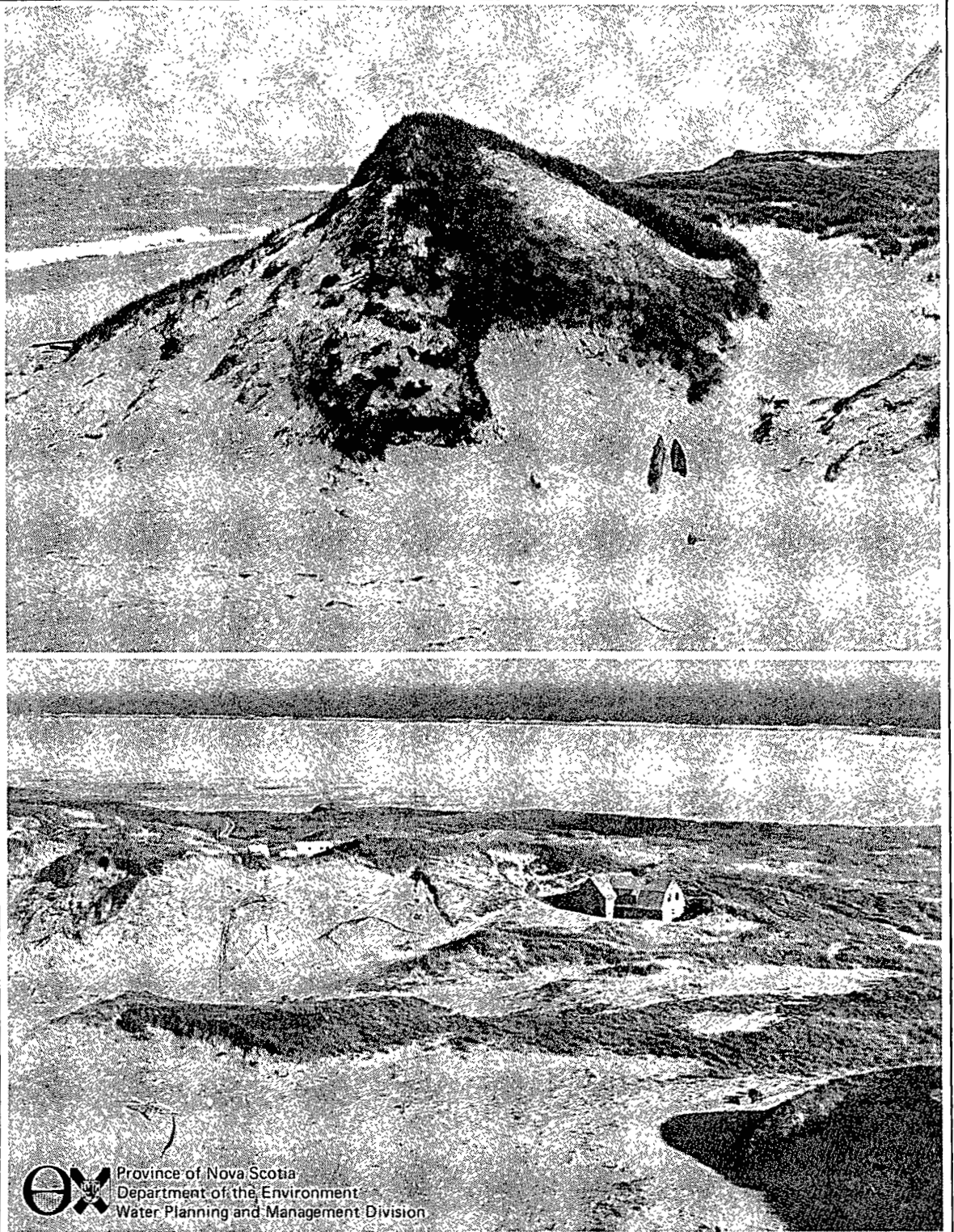

Province of Nova Scotia
Department of the Environment
Water Planning and Management Division

**WATER RESOURCES
AND
ENVIRONMENTAL GEOLOGY
OF
SABLE ISLAND
NOVA SCOTIA**

By T. W. Hennigar

Published under the authority of
the Honourable John Hawkins,
Minister of the Environment

Report No. 76-1

METRIC CONVERSION

1 inch (in.)	=	2.54 centimeters (cm)
1 foot (ft.)	=	0.305 meter (m)
1 mile (mi.)	=	1.609 kilometers (km)
1 acre (acre)	=	0.405 hectare (ha)
1 square mile (sq. mi.)	=	2.59 sq. kilometers (km ²)
1 cubic foot (ft ³)	=	0.028 cubic meter (m ³)
1 imperial gallon (imp. gal.)	=	4.546 litres (l)
1 acre-foot (ac.-ft.)	=	1219.7 cubic meters (m ³)
1 imperial gallon per day per foot (igpd/ft.)	=	14.9 litres per day per meter (lpd/m)
degrees Celsius (0c)	=	5/9 (°F - 32)
1 part per million (ppm)	=	1 milligram per litre (mg/l)

CONTENTS

	Page
Abstract	1
Introduction	2
Purpose and scope of investigation	2
General description of the area	2
Location and access	2
Land survey system	2
Physiography	4
Soils	7
Climate	7
Wind patterns	8
Vegetation	10
Wildlife	12
Previous Investigations	13
Field work and maps	13
Acknowledgements	14
Geology	15
Introduction	15
Bedrock	16
Surficial deposits	16
Sediment movements	17
Environmental geology	22
Protection of freshwater reservoirs	22
Protection of vegetative cover	24
Water Resources	25
Introduction	25
Surface Water	25
Groundwater	25
Tidal effects	31
Well yields	33
Freshwater balance of the island	34
Water Quality	36
Introduction	36
Surface water	36
Groundwater	37
Summary and Conclusions	40
References	42

ILLUSTRATIONS

	Page
Figure 1. Location and physiography of the Sable Island area . . .	3
Figure 2. UTM grid system used for location of reference points on Sable Island	3
Figure 3. Aerial view showing part of the flat south beach and portion of the north dune system breached by blowouts	5
Figure 4. Breached dune system with remnant dunes near high water	6
Figure 5. Average wind speed and maximum monthly percentage frequency on Sable Island for period 1955 to 1966. . .	9
Figure 6. Sand deposits accumulated in lee (SE side) of abandoned building	9
Figure 7. Average speed and percentage frequency of wind direction on Sable Island for period 1955 to 1966.	10
Figure 8. Freshwater pond with abundant vegetative growth . .	11
Figure 9. Colony of sea sandwort (a pioneer species) buried by new sand on west spit.	12
Figure 10. Composite grain size distribution curves of Sable Island sand	17
Figure 11. Location of benchmark buried under 4 feet of wind-blown sand between 1963 and 1971	19
Figure 12. Profile GIT showing changes monitored between April 1974 and April 1975	20
Figure 13. Profile 4 showing sediment movement during period April 1974 to April 1975	21
Figure 14. Diagrammatical illustrations showing three types of sand deposits and the cause of each	23
Figure 15. Generalized movement of groundwater and effect of waste disposal on well water	24
Figure 16. Idealized cross section showing a freshwater lens under an island, based on the Ghyben-Herzberg relation	26
Figure 17. Section along profile 2 showing approximate dimensions of the freshwater reservoir	27
Figure 18. Section along profile 1 showing approximate dimensions of the freshwater reservoir	27
Figure 19. Section along profile 3 showing approximate dimensions of the freshwater reservoir	28
Figure 20. Location of observation well 47 near center of island. . .	29
Figure 21. Response of water table to recharge from precipitation in observation well 47	30
Figure 22. Plot of hydrographs from wells located at various distances from the shoreline	31

Figure 23.	Plot of groundwater hydrograph from test hole 19, predicted tide levels, and precipitation	32
Figure 24.	Trilinear plot of chemical analyses of water samples collected on Sable Island	36
Figure 25.	Plot of chlorides with time of four wells monitored on Sable Island	38

TABLES

Table 1.	Summary of temperature and precipitation data for Sable Island 1971 to 1974	Page 8
Table 2.	Development of west spit, Sable Island, as determined from sequential air photographs between 1959 and 1973.	18
Table 3.	Hydrograph data from observation well 47.	30

APPENDICES

Appendix A.	Groundwater hydrographs from observation well 19 for 1972 to 1974	Page 44
Appendix B.	Groundwater hydrograph from observation well 17 for 1972	47
Appendix C.	Groundwater hydrograph of observation well 47 for 1973 and 1974.	48
Appendix D.	Plot of climatic data recorded at Sable Island station during 1972, 73 and 1974.	50
Appendix E.	Chemical analyses of water samples collected on Sable Island	53

WATER RESOURCES AND ENVIRONMENTAL GEOLOGY OF SABLE ISLAND, NOVA SCOTIA

ABSTRACT

The freshwater systems and the geological framework of Sable Island are unique in the Province of Nova Scotia. The geology of the island consists of interbedded aeolian and beach sands that are continuous to a depth of over 1,000 feet (300 meters). Several horizons of buried soil and peat are found at various depths providing the only apparent stratigraphy in this extensive sand bank. The mean effective grain size and the uniformity coefficient of these sands are about 0.01 inch (0.02 cm) and 1.5 respectively. Actual field measurements of infiltration indicated a mean value of about 75 inches (190 cm) per hour. Pumping test data also indicate a mean transmissibility of about 31,000 igpd/ft. (461,900 lpd/m) and a storage coefficient of about 0.36.

The mean fluid potential of the freshwater reservoir as monitored near the center of the island is between 3 and 4 feet (0.9 and 1.2 m) above chart datum. At several places on the island the fresh water lense has been breached by intruding salt water, thus segmenting the reservoir and resulting in a mixing of waters. The effects of tidal fluctuations are recorded in the reservoir to distances up to 1,000 feet (300 m) inland. Production wells developed in this reservoir may induce salt water intrusion by upconing, lateral inflow and vertical infiltration. Water use on the island has in the past satisfied the domestic demands of the inhabitants and the requirements of Mobil Oil Canada Limited, for their exploratory oil and gas drilling program.

Vehicular movements and construction activity on the island must be carried out with caution because of the destructive influences these activities may have on the highly sensitive and fragile dune systems which form most of the island's topography. Also, it has been shown that the proper use of barriers can be an effective method of accumulating windblown sand to modify and/or repair the terrain.

INTRODUCTION

PURPOSE AND SCOPE OF INVESTIGATION

With the increasing interest in and exploration activity on Sable Island the needs for potable water are being stressed. A good deal of information is required by the various government agencies and oil companies involved in exploration in the Sable Island area, to better determine, develop, and manage the resources of this island. This is the first field study to explore the freshwater conditions on the island.

At present, the only permanent residents on the island are federal government employees associated with the upper air station which provides atmospheric data to the regional weather network. However, with the expansion in exploration and other interests on the island, both the development of water supplies and disposal of the increasing amounts of solid and liquid wastes will have to be planned and practised with a better understanding of the dynamic geological environment and the fresh water regimen of the island.

Included in this report are discussions of:

1. the geology of the area
2. wind patterns of the island
3. precipitation
4. vegetation
5. sediment movements in the dunes and beaches
6. yields of shallow, small diameter screened wells
7. water quality of both surface and groundwater
8. environmental geology
9. water level fluctuations

GENERAL DESCRIPTION OF THE AREA

Location and Access

Sable Island is located on the Scotian Shelf about 100 miles (161 km) from Canso Head which is the nearest part of the mainland. The geographic location of the Island is approximately 60° west longitude and 44° north latitude. This location makes it neither the most easterly nor the most southerly part of the province. (Figure 1). It lies approximately 140 miles (225 km) due south of Louisbourg, and about 225 miles (362 km) due east of Liverpool. It is located about 180 miles (290 km) southeast of Halifax. In terms of features of the Scotian Shelf, it lies about 20 miles (32 km) north of the continental slope and about 30 miles (48 km) from the Gully, a very significant erosional feature in the shelf to the east of the Island.

Land Survey System

The Universal Transverse Mercator (UTM) projection is used by the Surveys and Mapping Branch of the Department of Energy, Mines, and Resources for its topographical series at scales of 1:250,000,

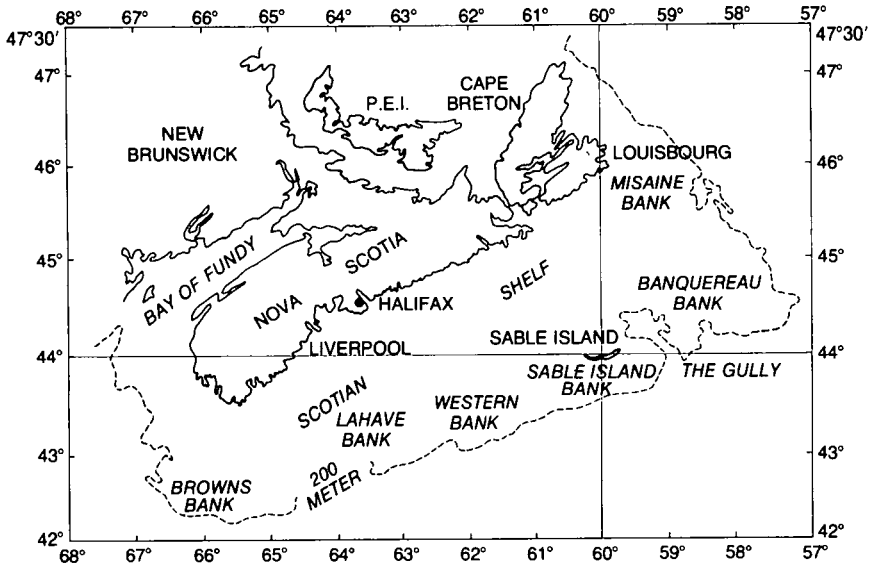

Figure 1. Location and physiography of the Sable Island area.

1:125,000, 1:50,000 and 1:25,000. This projection divides the globe into 60 north-south zones, each with 6 degrees of longitude, between 84 degrees north latitude and 80 degrees south latitude. Sixteen of the zones, numbered seven to twenty two from the west coast, cover Canada. Each zone has a central meridian and can be divided into a basic set of map sheets of a convenient size.

The grid, used as the basic element of identification, is standard on

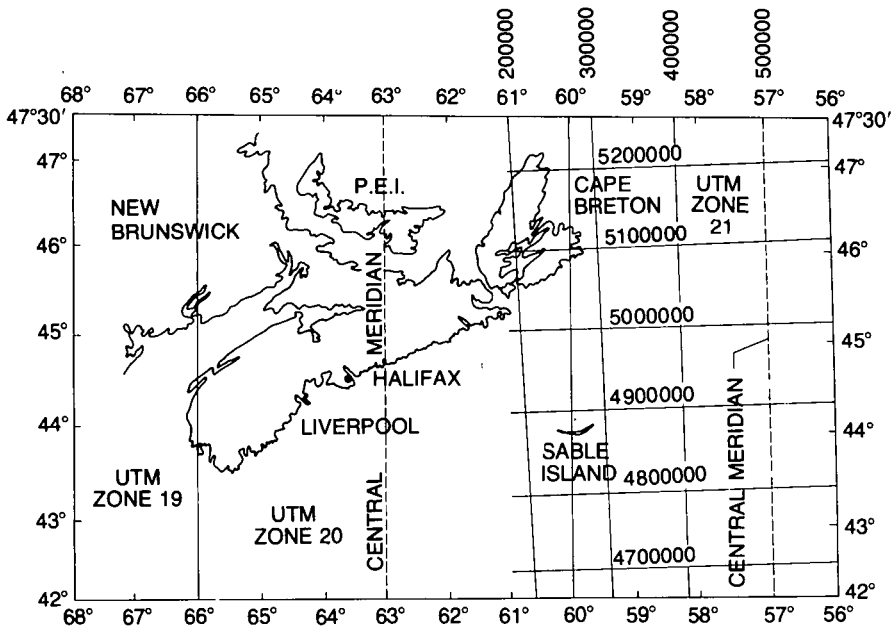

Figure 2. UTM grid system used for location of reference points on Sable Island.

all UTM maps and is made of straight lines. The basic grid lines, both horizontal and vertical, are drawn 100,000 meters (about 62 miles) apart. All vertical lines parallel the meridian while the horizontal lines parallel the equator.

The squares formed by the intersection of the 100,000 meter lines are shown in Figure 2. These are further sub-divided by 1,000 meter lines on the 1:50,000 topographical map of Sable Island. On each topographical map published, the UTM zone number and the grid spacing used is indicated.

All horizontal lines (northings) are measured in meters from the equator. Vertical lines (eastings) are measured from an imaginary line lying 500,000 meters west of the zone's central meridian. The number of meters north of the equator of the lowest horizontal grid line on a map is always shown in the lower left corner. Also, the number of meters east of the zero vertical line is shown in the lower left corner opposite the farthest left vertical line on the map.

As an example, the UTM location, for test hole 19, Zone 21 2580 48681 is unique and easily identified. Thus, the test hole is 258,000 meters east of the zero grid for Zone 21, and 4,868,100 meters north of the equator. To simplify this number in any given zone, at the scale used for this study, a six number reference can be used. The location of test hole 19 can be referred to as 580681. The easting number always being the first one given.

Physiography

Sable Island is the emerged part of the larger Sable Island bank. This sand bank is outlined approximately by the 100 meter contour shown on bathymetric chart 801 produced by the Canadian Hydrographic Service, 1969. This broad bank consists of sand with less than 50 percent gravel (King 1970). The overall dimensions of the bank are roughly 100 miles (161 km) in an east-west direction and approximately 50 miles (80 km) in a north-south direction. This large shallow platform of clean, uniform, and unconsolidated sand is subjected to the forces of varying ocean currents, tides, and other disturbances. These result in movements of large volumes of sediment and the formation of significant geomorphological features. Also, the surrounding topography of the Scotian Shelf is indented and consists of many erosional features. MacLean and King (1971) noted the very irregular topography across the Shelf in the Banquereau and Misaine Bank areas northeast of Sable Island. These and other studies reveal that the underlying bedrock of the Scotian Shelf in that area has undergone several periods of severe subareal erosion.

Depressions in the Laurentian Channel, which incise Cretaceous and Pennsylvanian rocks, have been infilled with possible Tertiary sediments. King and MacLean (1971) concluded, on the basis of their continuous seismic reflection studies in the area, that this channel was developed by glacial erosion along a pre-existing river system. Accepting this hypothesis, it would be necessary that the sea level or elevation of the bank be more than 200 feet (60 m) different than it is today. It is

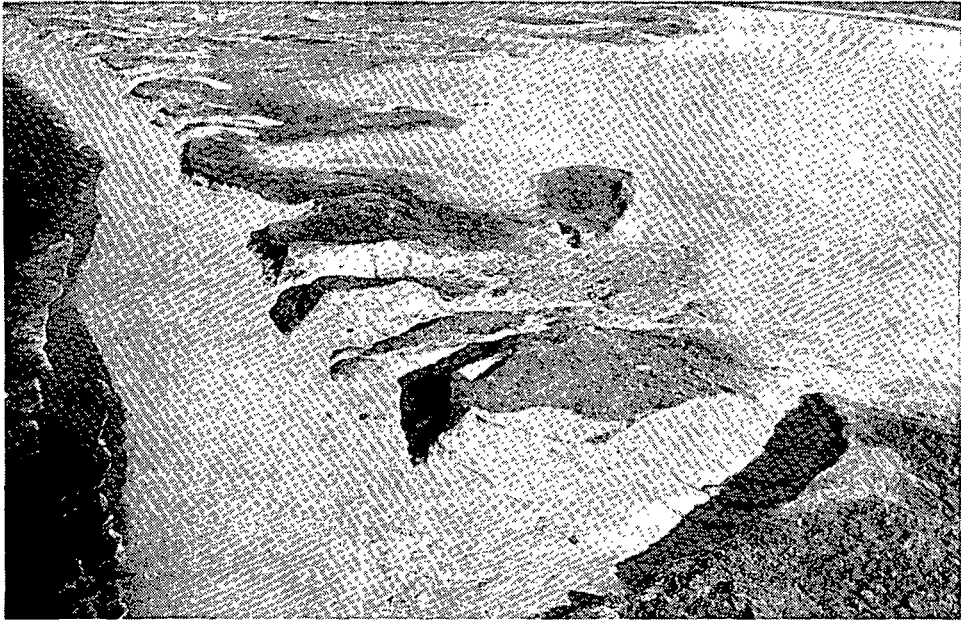

Figure 3. Aerial view showing part of the flat south beach and a portion of the north dune system breached by "blowouts".

postulated by Stanley and Cok (1968) that much of the high relief on the eastern half of the Scotian Shelf is a result of glacio-fluvial erosion.

The island (Figure 3) is a crescent shaped series of sand bars and dunes which extends approximately 25 miles (40 km) in length. The maximum width of the island is a little less than one mile (1.61 km). The physiography of the island includes four basic parts; the west spit, the main body, the flat beaches, and the east spit.

The west spit, which extends a distance of approximately 4 miles (6.4 km), has a width of about 1,000 feet (300 m). Its average elevation is approximately 5 feet (1.5 m) above mean sea level with a slight depression along its center. The extremity of the spit waxes and wanes with various ocean current and storm influences that are constantly shifting the offshore bars and changing the dimensions and shape of the spit.

The main body of the island is approximately 17 miles (27 km) long and is defined by two well developed systems of sand dunes paralleling the north and south beaches. The two main dune systems are significantly different. The system on the south side is less continuous and consists of elevations generally reaching 30-40 feet (9 to 12 m). The dune system on the north beach is more continuous and reaches elevations in some areas of 80-85 feet (24-26 m) above mean sea level. The general shape and position of these dunes reflect the prevailing storm trends and wind direction. Many of the blowouts' axes are oriented in the NW-SE direction which corresponds to that of major high velocity winds. Re-entrants occur from the beach to the centre of the island where the



Figure 4. Breached dune system with remnant dunes near high water.

elevation is only a few feet above sea level. These low areas are extremely susceptible to flooding by high tides. Debris floated in reveals that the encroachment in many areas extends to the central part of the island. Several large valleys and basins exist between these dune systems where large scale erosion has led to spectacular blowouts. The inland dune slopes are commonly gentle, whereas the coastal slopes are considerably steeper (Figure 4) because of the constant erosion of the base of these dunes by high tides and strong winds. The lower areas in the central part of the island are relatively flat with slight undulations of sand. Also, in the areas where the elevation is very low, small fresh water ponds are normally found, especially during seasons when the water table is high.

The large flat expanse of sand on the south side has been developed over the last 150 years to form the beaches of Lake Wallace, the main enclosed salt water body on the island. According to the map produced by DeBarres (1763), this area was open on both sides to the sea as a lagoon. The Bayfield and Shortland map (1851) shows that this lagoon has been breached by sand bars and since that time, the area of Lake Wallace has been steadily decreasing as infilling by sand has continued. The entrance to the pond, through its north bar, was closed by a storm in 1833, and never reopened (Goldthwait, 1924).

The fourth physiographic part of the island is the east spit which is an area of about 4 miles (6 km) long and 1,000 feet (300 m) wide. The elevation varies from about 5 to 10 feet (1.5 to 3 m) where sand deposits have accumulated. This spit, as well as the west spit, provides very little

opportunity for development of any type of vegetation. These areas bear the brunt of strong ocean currents and combined forces of atmospheric disturbances and storm patterns which modify the size, shape, and location of the spits regularly. However, colonies of sandwort appear quite prolific on the higher portions of the spits that are protected from frequent flooding.

Soils

In many areas the soils available will determine the type of farming carried out and the types of crops raised. One of the most important factors influencing the type of soil developed in an area is the parent material from which it is derived. Soils, by definition, are highly complex physical mixtures of mineral and organic materials that make up the soil solids. The remaining volume of the soil consists of pore spaces containing various mixtures of air and water. The mineral fraction of soil consists of gravel, sand, silt and clay. Organic matter in soil ranges from freshly added plant and animal remains to the slowly decomposing group of complex compounds called humus. The soils found on Sable Island have a deficiency of all the common soil fractions with the exception of sand sized mineral particles.

Climate

The climate of Sable Island is controlled to a large extent by marine conditions and moderated by ocean influences. It is, therefore, somewhat more moderate than the mainland climate. Meteorological records of Sable Island have been kept since the mid 1800's. The thirty one year mean annual total precipitation for the island during the period 1940 to 1970 is 50 inches (127 cm). This compares to a mean annual total precipitation of 51.9 inches (132 cm) at Halifax for the same period. Also, comparison of temperatures between Sable Island and Halifax for the same period show the mean daily temperatures for both places as 45.6 degrees Fahrenheit (7.6 degrees Celsius). Comparison of extreme maximum daily temperature during the period of record for Halifax shows that the maximum temperature is 94° F (34.4° C) and the extreme minimum is minus 13° F (-25° C). For Sable Island, the extreme maximum temperature is 86° F (30° C) whereas the extreme minimum temperature is only minus 3° F (-19.4° C). Another indication of the more moderate climate of the island is reflected in the statistics of number of days with frost. The mean number of days with frost per year is only 102 for Sable Island as compared to 128 for Halifax, and 190 for Truro.

The seasonal distribution and variations in the precipitation of the island are quite significant. During the period 1941 to 1970, the mean minimum monthly precipitation of 3.12 inches (7.92 cm) occurs during June, whereas the mean maximum monthly precipitation of 5.18 inches (13.15 cm) occurs during December. Also during this 30 year period, the annual precipitation has varied from 21.6 inches (54.86 cm) in 1944 to 65.6 inches (166.62 cm) in 1964. This represents a variation of over 200 percent during the period of record. For the period 1891 to 1972, the highest monthly precipitation of 17.92 inches (45.51 cm) was recorded during the

Table 1. Summary of temperature and precipitation data for Sable Island 1971 to 1974.

	1971		1972		1973		1974	
	Total Precipitation (In.)	Mean Temperature (°F.)	Total Precipitation (In.)	Mean Temperature (°F.)	Total Precipitation (In.)	Mean Temperature (°F.)	Total Precipitation (In.)	Mean Temperature (°F.)
January	4.95	28.4	7.25	31.5	4.92	29.8	4.30	30.1
February	4.64	29.4	5.78	27.4	6.99	30.4	5.07	29.4
March	5.90	35.3	4.71	32.4	5.09	32.7	3.15	31.9
April	4.34	40.7	5.16	36.2	3.17	37.0	2.60	39.0
May	3.93	46.8	5.03	43.0	4.71	43.1	4.76	40.8
June	2.80	52.6	3.99	54.2	4.72	52.9	6.89	49.5
July	2.40	61.3	1.83	61.2	2.53	62.2	3.24	56.0
August	1.56	65.3	3.44	64.0	3.90	63.5	2.04	62.9
September	3.58	61.5	1.03	60.7	3.67	59.6	4.84	60.7
October	1.26	53.4	6.46	51.9	5.13	51.7	3.60	50.4
November	8.02	44.3	4.85	41.9	3.55	42.0	5.86	44.3
December	5.20	33.7	6.65	33.9	4.92	39.8	7.76	37.6
TOTAL	48.58	552.7	56.18	538.3	53.30	544.7	54.11	532.6
MEAN	4.05	46.1	4.68	44.9	4.44	45.4	4.51	44.4

Note: 1 inch = 2.54 centimeters
degrees Celsius (°C) = (°F - 32) 5/9

month of August 1964. The minimum monthly precipitation of 0.34 inches (0.86 cm) was recorded in May, 1944. During seventy-seven years of records, the greatest precipitation recorded in a twenty-four hour period was 6.54 inches (16.61 cm). This represents a rainfall intensity of about 0.25 inches (0.64 cm) per hour. Bruce (1968) shows the twenty-four hour rainfall with a ten year return period as 5 inches (12.70 cm) for the Sable Island area. Table 1 shows a summary of temperature and precipitation data for Sable Island during the years 1971 to 1974.

Wind Patterns

Several interesting trends and variations are evident from analyses of the wind records on Sable Island. The following discussion is based on records from the period 1955 to 1966, and an anemometer that is located near the centre of the island at a height of approximately 40 feet (12 meters). Figure 5 shows a plot of the average wind speed and maximum monthly mean percentage frequency. From this diagram, it appears that the two main components of wind direction are from the northwest and southwest. It is interesting to note that during the period May to September, this component is largely southwest. This is particularly so during July when the wind has a southwest vector 26 percent of the time. Furthermore, from this figure it is apparent that the average wind speed during this period is at a minimum. Southwest winds, although more dominant, normally have smaller velocities, whereas the less frequent northwest winds blow with a much stronger force. The effect of these winds on the dune structures is shown in Figure

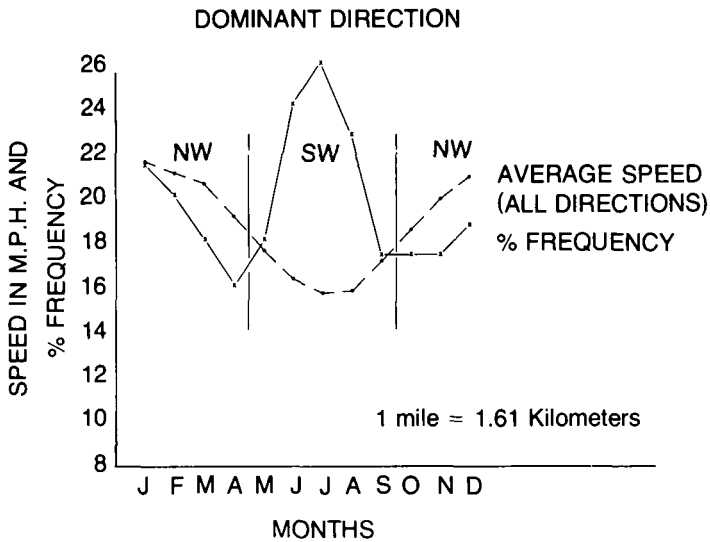

Figure 5. Average wind speed and maximum monthly mean percentage frequency on Sable Island for period 1955-1966.

6. The annual mean speed in all directions during this period is about 16 miles (26 km) per hour, with a maximum observed hourly speed of 84 miles (213 km) per hour from the southwest.

Gusts of wind with speeds greater than 100 miles (161 km) per hour have been recorded at this station. During the storm of October 1974, the upper limit of the anemometer, which is calibrated to measure speeds of

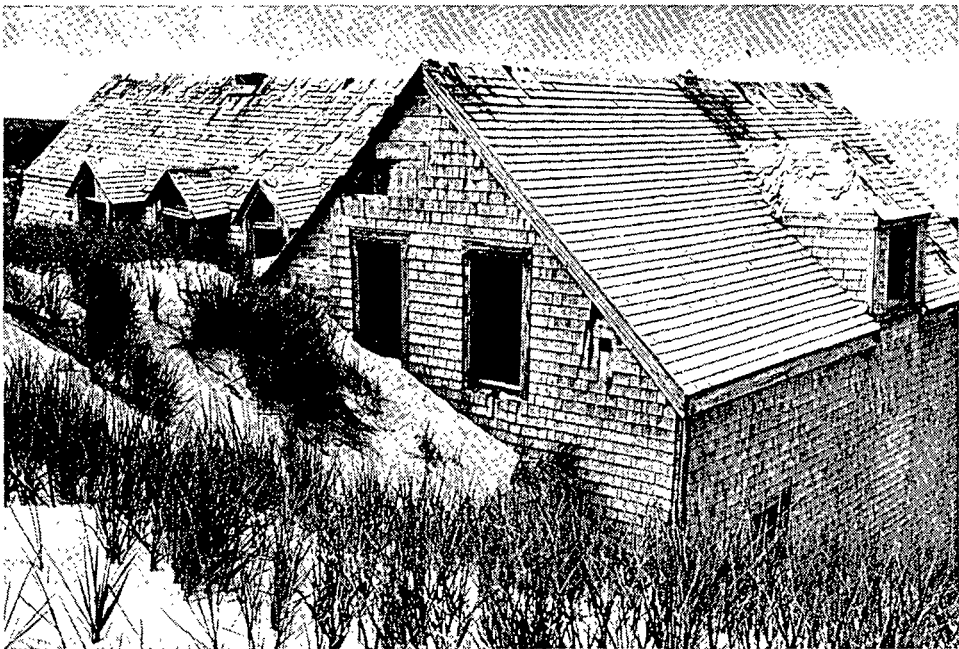
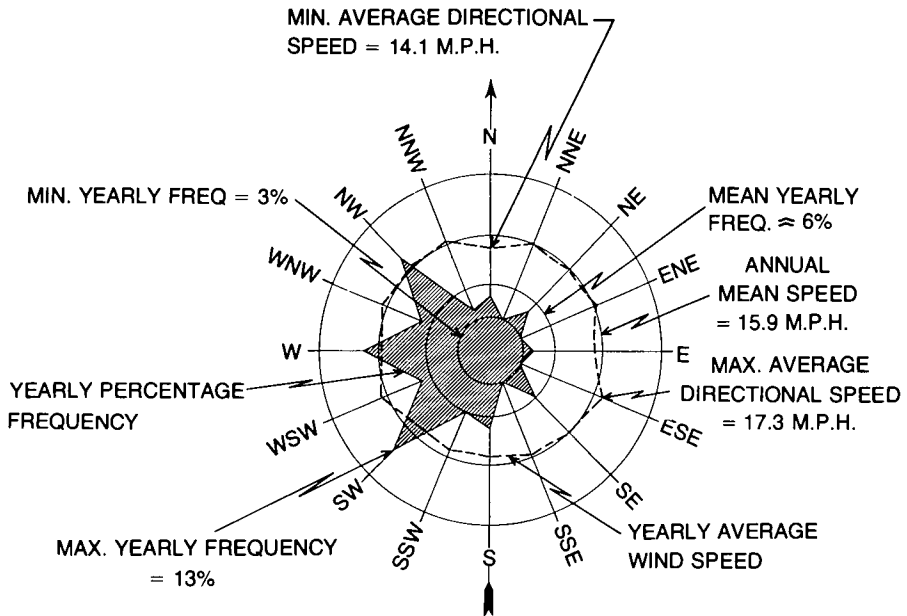

Figure 6. Sand deposits accumulated in lee (SE side) of abandoned building.



FREQ. WITH W COMPONENT = 61%
 MAX. MONTHLY % FREQ. = 27 - JULY - SW
 MIN. MONTHLY % FREQ. = 1 - JULY, AUG. - NNW

CALM < 1%
 ANNUAL MEAN SPEED = 15.9 M.P.H.
 MAX. OBS. HOURLY SPEED = 84 M.P.H. - SW
 MAX. GUST > 100 M.P.H.
 MAX. MEAN MONTHLY SPEED = 23.4 M.P.H. - JAN. - ESE
 MIN. MEAN MONTHLY SPEED = 9.0 M.P.H. - JUL. - NW

Figure 7. Average speed and percentage frequency of wind direction on Sable Island for period 1955-1966

up to 100 miles (161 km) per hour, was exceeded. It was estimated, by staff who were on duty at the time, that the wind speeds were reaching close to 120 miles (193 km) per hour in gusts.

Figure 7 shows a rose diagram of both wind speed in miles per hour and the percentage frequency of wind direction on Sable Island during the period of 1955 to 1966. The westerly component of wind direction is strongly indicated in the diagram from the yearly percentage frequency data. The maximum yearly frequency of wind direction is 13 percent from a southwest direction, whereas the minimum yearly frequency is only 3 percent from the east northeast. The most common wind direction has a westerly component and 61 percent of the time the wind blows from a westerly direction. Also, it is interesting to note that less than 1 percent of the time the winds are calm on the island.

Vegetation

The most recent authoritative account of the flora of Sable Island by Erskine (1952) lists both the native and introduced plants that he

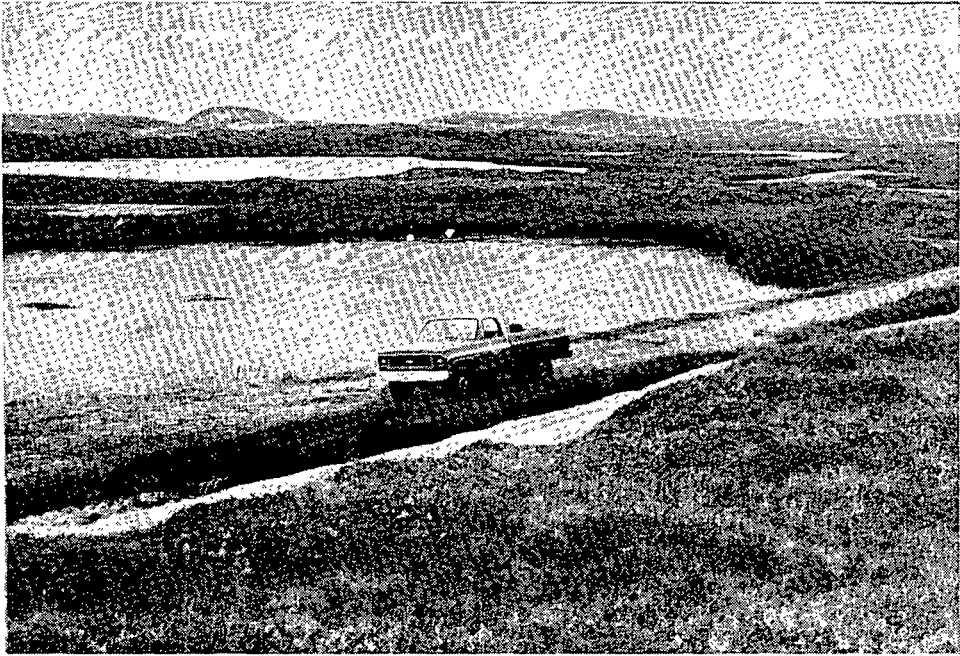

Figure 8. Freshwater pond with abundant vegetative growth.

collected there. Erskine divided the terrain of Sable Island into six categories and describes each with its own flora. These six categories and the associated types of vegetation can be listed as: 1. The sea beach where the only plants successful in establishing a foothold in the constantly moving and saline sand are the highly salt resistant types such as sandwort. 2. The high dunes which are being continually eroded from the seaside and built-up on the landward side by moving sand. Most types of plants cannot survive in such a dynamic type of environment, or where the moisture content is so low. Therefore, the chief flora in this area consists of marram grass, beach pea and seaside goldenrod. In one area north of the west end of Lake Wallace, the high narrow dune has a thin covering of native bluegrass. 3. The middle of the island, where less and finer sand is deposited, Erskine refers to as the low dunes. These are covered with much low vegetation, including beach grass, common juniper, and different types of low shrubs. In the open dunes are evening primroses and, near the houses and ponds, there is an abundance of centaury. In addition chafe wheat, which is also known in Prince Edward Island, is found in this area. 4. The low flat areas near the ponds where cranberries grow very abundantly; bog club moss and orchids are common; and the roots of phreatophytes tap the water table (Figure 8). Brackish ponds have sago pond weed, and marsh arrow grass and other water weeds flourish where the water table is very near the surface. 5. The salt flats where eelgrass is common, on the north shore of Lake Wallace. Here siltation is not as rapid as in the other areas. 6. The areas around the buildings, where various weeds, grasses, and clovers are found.

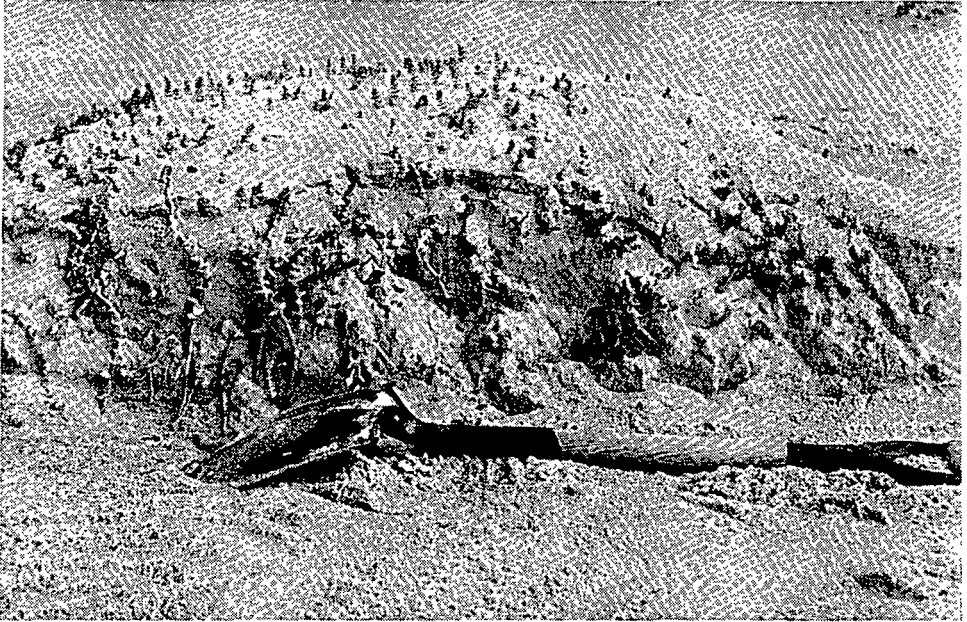

Figure 9. Colony of sea sandwort (a pioneer species) buried by new sand on west spit.

Dune plants have often been separated into two main types of species: the pioneer species, and the dune building species. The pioneer species tends to grow better near the sea, just above the high tide mark on the crest of the beach in saline conditions. The common grass types of the pioneer species are sand catch grass, sea sandwort and sea rocket. Grass types of the dune building species occur more commonly on the crest of dune ridges. Types of grass of this species are marram grass, lime grass and beach pea.

Of these different plant types, the ones most suitable for vegetating the dune areas are those that can meet the following five criteria: 1. be resistant to saline conditions 2. be strong enough to prevent abrasion of the plant by the sand blast effect of sand particles moving at high velocity 3. be able to withstand periods of being buried alive 4. be able to withstand the effects of dry winds, and continuous exposure to high winds 5. the plants must have long roots or rhizomes that tend to form a mat in the sand and bind the particles together, thus assisting to hold them against the forces of erosion. Plants that can meet all these criteria are marram grass, lime grass, sea sandwort and sand catch grass. The only one of this species that is not found on Sable Island is the sand catch grass. Figure 9 shows a colony of sea sandwort performing its pioneering function in an exposed and saline environment on the west spit.

Wildlife

Sable Island is teeming with various types of animal life. The most famous inhabitants of the island are the horses that have been there for over two hundred years. Their numbers normally vary between two

hundred and three hundred (Welsh, 1973), and it is believed that the size of this population may be in some balance with the life sustaining capabilities of the island.

Sable Island is also home to some three thousand grey seals and about one thousand three hundred harbour seals. MacLaren and Bell (1972) report sightings of over three hundred species of birds on the island. Among the more resident birds are black ducks, red-breasted mergansers, sandpipers, blue winged and green winged teals, Ipswich sparrows, terns, and gulls.

PREVIOUS INVESTIGATIONS

A large number of reports and maps have been prepared on Sable Island, the earliest dating in the 1700's. Zimlicki and Welsh (1975) have prepared a summary of such material which is readily available. This report is presented in three parts: Part 1 includes: a) Sable Island, an annotated bibliography, with over forty references on the geology of the island. About one hundred and fifty other references are listed under meteorology and climate, history, botany, zoology, miscellaneous, general, and television and film, b) a listing with locations of about seventy available maps and over twenty sources of aerial and ground photography, and c) a listing of fourteen contemporary research projects and data collection activities. Part II is an annotated listing of methods and techniques of dune restoration with a brief evaluation of same; Part III is a selected listing of published material on the movement of sediment in the nearshore zone.

Much interest has been shown in Sable Island since it was first sighted by Cabot in 1497. The first attempts to colonize the island were made in the 1500's. The Baron de Levy in 1539 and the Marquis de La Roche in 1598 both made unsuccessful attempts at colonization. In 1801, the Province of Nova Scotia established a permanent station on the island to assist survivors of shipwrecks. Since that date, there has been either provincial or federal government representation on the island, to maintain life saving stations until the early 1950's and, since 1891, to man the meteorological station. Also, during the first half of the 20th century, a wireless radio station was maintained on the island by the Department of Transport. In 1873, the first navigation light was constructed on the west end of the island. Today, a light exists on both the west and east ends of the island. A radio beacon is located on the island as a navigational aid to aircraft and ships.

FIELD WORK AND MAPS

Field work for this report began on the island during the summer of 1971. At that time, a number of test holes were drilled, three water level recorders were installed, several water samples collected, and surveying carried out to determine the elevations of reference points.

During the summer of 1972, aerial photographs were obtained at scales of 1:8,000 for the main part of the island and 1:6,000 for the west

and east spits. During the year, further water sampling was carried out; pumping tests were conducted; infiltration tests were carried out; new observation wells were constructed, and water well recording instruments were installed.

In June 1973 a resistivity survey was carried out to aid in the determination of the freshwater-saltwater interface under the island. Areal photographs were obtained through the Canadian Centre for Remote Sensing at a scale of 1:12,000. Monitoring of both water level fluctuations and water quality continued during the year.

During April 1974, several profiles were established along which sediment transport could be monitored. The elevations of these stations, as well as the water level readings, are expressed in feet above chart datum. This datum is by international agreement, a plane below which the tide will seldom fall. The Canadian Hydrographic Service has adopted the plane of lowest normal tides as Chart Datum. Mean sea level at Sable Island is reported to be 3.3 feet (0.9 m) above this datum.

Chemical analyses of water samples were done by the Chemical Laboratory for Investigation of Minerals, at Nova Scotia Technical College, under Mr. Wade Gates, until mid 1974. Since that time, chemical analyses have been done at the Environmental Chemistry Laboratory, Pathology Institute, under Mr. R. McCurdy.

ACKNOWLEDGEMENTS

This study was initiated under the Nova Scotia Department of Mines, and the services provided for the base camp and field equipment were supplied through that Department. The surveying services of Mr. Ian MacDougall and the cartographic services of Mr. D. Bernasconi and staff are gratefully acknowledged. The mechanical services of Mr. B. Pitts and staff were necessary to ensure that mobilization and camp amenities were provided.

Execution of the project would not have been possible without the co-operation of other government agencies and Mobil Oil of Canada Limited, who were also involved in various programs on the island. Capt. G. Williams, District Marine Agent, Ministry of Transport, made it possible for the shipment of supplies and equipment to the island on Canadian Coast Guard vessels. Mr. P. Thorne, Officer-In-Charge of the Upper Air Station on the island, and his staff unselfishly provided assistance and technical advice on the various problems that arose. This staff also maintained the water level recorders and tended the hydrograph charts during various stages of the study.

Mr. U. C. Holm, through his dedication to the job and his special interest in the island, was of outstanding value to the project.

Consultations with the Nova Scotia Communications and Information Centre regarding photographic technicalities were both very helpful and much appreciated. Several of the photos, including the one on the cover, were taken by Mr. E. C. Norwood of the Centre.

GEOLOGY

INTRODUCTION

For the geologist, Sable Island poses many problems and unanswered questions. Within the seemingly simple layers of sand lie the secrets of the island's origin and the time that it has been in existence.

During the last twenty years, the Scotian Shelf has been the focal point of several geological studies, mainly because of the potential development of oil and gas reservoirs. Therefore, these recent efforts have been mainly geophysical studies to interpret and better understand the sequence of rocks, the depth of the sediments, and the structures that are contained therein. On the basis of this work it has been found that both the glacial and post glacial geology of Sable Island are closely related to that of the Scotian Shelf. During the last glaciation, the Sable Island Bank would have emerged with the outline closely following the present 100 meter contour. This would result in a land area about 150 miles (242 km) long and 50 miles (81 km) wide. Terresmae and Mott (1971) report a sample of sandy peat obtained from Mobil Oil Sable Island No. 1 well (C-67) at a depth of 60 feet (18 m). The radio carbon age assigned to that sample was 10,900 plus or minus 160 (GSC-935) years BP. This particular date very closely coincides with the generally accepted end of the glacial period in this part of North America. Other data suggest that the sea level has been rising steadily since that time, and that Sable Island has also been submerging to reach its present day level, or equilibrium with sea level. Also, as MacLean and King (1971) have indicated, the Scotian Shelf during the glacial period was partly emerged and sediments on the Shelf were subjected to sub-areal erosion.

It is supported by the author that glacial outwash sediments from the continent have been the source of material for Sable Island. It is believed that these materials have been reworked on the Shelf and the finer fractions of sand deposited on the Sable Island Bank. The overall texture of the surficial deposits in the area changes in a downstream and down-gradient direction from the glacial front as it existed during that period. The generally decreasing grain size of the material in a southeasterly direction, as well as the increasing sorting of materials in the same direction, would help support the theory that these sand deposits on the Scotian Shelf are outwash material from the glacial debris dumped on the margin of North America, especially off the Nova Scotia coast.

Cameron (1965) shows the location of Sable Island on the Scotian Shelf and the major principal ocean currents in that area. The presence and the shape of the island may be partially accounted for by the influence of these strong oceanic currents. One current, the Gulf Stream which passes south of Sable in a north easterly direction, exerts a strong influence on the south side of the island. Meanwhile north of the island, the St. Lawrence and the Strait of Belle Isle currents move in a

southwesterly direction to form a strong influence for currents to move in a counterclockwise direction around Sable. Slight variations in both the current velocity and/or direction, as well as the further impact of atmospheric and tidal effects, could well explain to a large degree the tremendous amount of sand movement on the Sable Island banks, spits, and along the beaches.

The geology of the island is unique to Nova Scotia in that the complete sequence of surficial materials are sand sized particles. Also, the younger subsurface bedrock units are not represented on the mainland. There has been no bedrock outcropping, no clay deposits, nor a soil profile developed on the island.

BEDROCK

During the last eight years, approximately sixty wells have been drilled in the offshore area. These have added a tremendous amount of subsurface data to one of the last geological frontier areas of Canada. Mobil Oil Sable Island No. 1 well drilled in 1967 near the centre of the island was bottomed at 15,106 feet (4,607 m) in Cretaceous sediments. In that well, 980 feet (294 m) of Quaternary sediments, 3,070 feet (936 m) of Tertiary, and 11,056 feet (3,372 m) of Cretaceous sediments were reported by Munro and Brusset (1968). From geophysical data, the total depth of the sedimentary series overlying the basement near the continental edge in the Sable Island area is interpreted to be more than 20,000 feet (6,100 m).

One of the first attempts to piece together the Cenozoic and Mesozoic stratigraphy of the Scotian Shelf was presented by MacIvor (1971). Using the subsurface data from approximately twenty offshore wells, he has subdivided the sediments into three groups, twelve formations, and four members. The oldest stratigraphic unit recognized in that report is salt and is identified as early Jurassic in age. The Cenozoic section was finally truncated by glacial erosion.

SURFICIAL DEPOSITS

Both seismic and borehole records indicate that the glaciated platform in and around Sable Island is underlain by approximately 1,000 feet (300 m) of Quaternary unconsolidated sands. Although a good deal of information has been collected on the subsurface geology of the Sable Bank over the last few years, relatively little interest has been shown in the surficial geology of the island. The earth materials composing the surficial geology of the island are quite homogeneous. The only earth material found on the island is a sand of particle sizes that range from about 0.003 to 0.07 of an inch (0.008 to 0.18 cm) in diameter. Figure 10 shows the composite grain size distribution curve of samples collected from both surface sites and subsurface sites at ten random stations on the island.

Horizons of organic material are found at various depths on the island. The deepest logged and sampled organic horizon is at a depth of 60 feet (18 m) as found in the Mobil Oil Sable Island No. 1 (C-67) well. Others are found at sea level, or in sections on the slopes of dunes. The

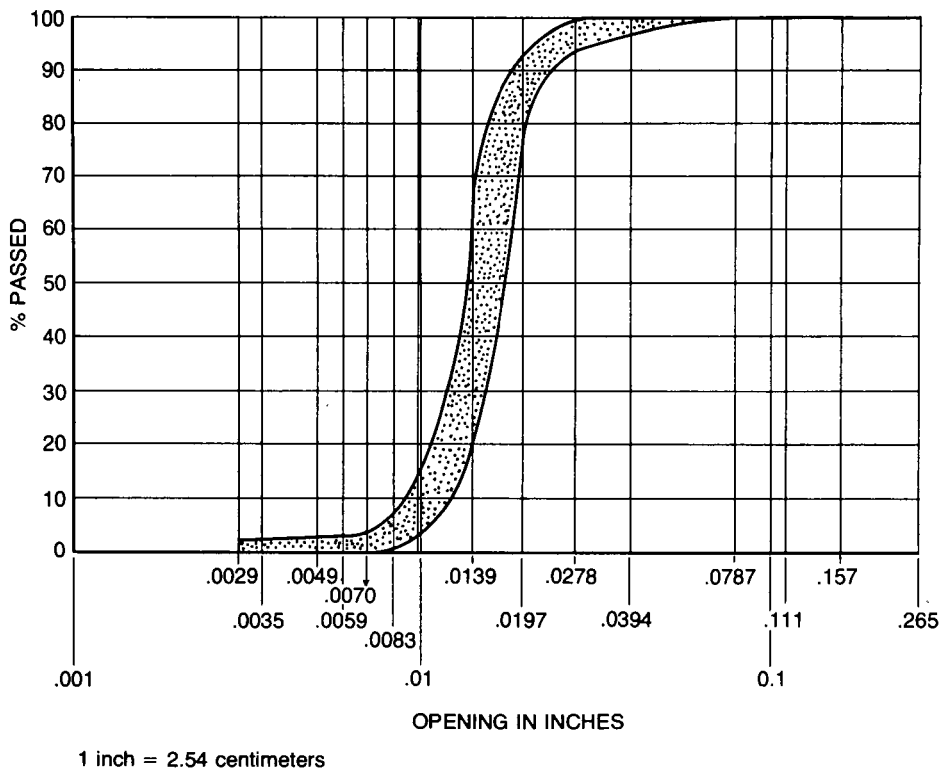

Figure 10. Composite grain size distribution curves of Sable Island sand.

occurrences of these organic horizons give rise to much speculation as to their age and their history. Terasmae and Mott, (1971), indicate that no Pleistocene deposits or surfaces are exposed at present on the island. The numerous organic horizons exposed along the erosional faces of dunes are two hundred to three hundred years old. The presence of these are probably accounted for by the active erosional and depositional forces at play on the island. It is conceivable that the present so called stabilized or heavily vegetated areas could in fact be suddenly buried by wind blown sand. If this does occur, the formation of a new dune in such an area could give rise to the development of a new organic horizon in the material that has been recently buried.

SEDIMENT MOVEMENTS

An appreciation of sediment movements on the island can be developed by enduring a storm there and noting the pre and post storm conditions. Over the years since 1800, several of these storms and the resulting changes have been documented in reports of government officials.

“During the four years between 1809 and 1813, 4 miles were removed from the western end, and the signal station had to be moved inland. In 1813, a single gale trimmed away an area approximately 40 feet wide and 3 miles long. In the thirty years prior to 1833, 11 miles of the western end disappeared, and the

signal station there was moved three times. At least 5 miles of the 11 miles must have been from the outer part of the west bar, where waves formerly broke. In 1881, a gale removed a strip 70 feet wide and half a mile long; a month later a second storm trimmed away 33 feet from the whole length of the island; and soon after it, a third one removed an area 48 feet wide and a quarter mile long. A lighthouse which had been built near west point in 1873, was moved eastward a quarter of a mile in 1881, 1½ miles farther in 1888, and is now (1915) again in danger of being washed away."

(Goldthwait, 1924, p. 145)

Several reports and discussions over the last few years have centered around the stability of the island and the amount of movement that the island has actually undergone. Cameron (1965) indicated that the records, from the earliest map in the mid 1700's to photography taken in the late 50's, show that the island is moving or migrating in an eastward direction. However, Evans-Hamilton (1972) state that Sable Island is neither drifting to the east nor rapidly washing away as predicted, although they indicate that some erosion has occurred.

It is the belief of the author that the changes occurring on Sable are not necessarily all destructive or final. For example, the changes on the island, as recorded by Cameron (1965) indicate that during the period 1766 to 1955 the island moved progressively eastward and that both the west spit and the east spit moved in an easterly direction. However, between 1955 and 1964, both the east spit and west spit have migrated westward (Cameron, 1965). This would suggest that the long term movement trends of the island, especially considering the past two hundred years of record, may be cyclical. Evans-Hamilton (1972) indicate that between 1900 and 1947 the east spit eroded. During 1947 to 1955 the east spit increased in length by about 4.5 miles (7.25 km), and by 1960 all that had been added was lost again. To support the westward movement of the island, Table 2 shows the behavior and the growth of the west spit for the period 1959 to 1973. These measurements, made from aerial photographs and using a reference point near the west end of the island, show that the west spit has actually been extended by over one and a half miles (2.4 km).

Since 1973, the accumulation of sand on the west spit has been

Table 2. Development of west spit, Sable Island, as determined from sequential air photographs between 1959 and 1973.

Date of Photography	Source	Length of west spit	
		feet	meters
April 14, 1959	R.C.A.F.	10,800	3244
May 25, 1963	E.M. & R.	15,200	4636
December 6, 1971	Capital Air Survey	15,600	4758
May 29, 1972	Capital Air Survey	17,400	5307
May 14, 1973	C.C.R.S.	18,600	5673



Figure 11. Location of benchmark buried under 4 feet of windblown sand between 1963 and 1971.

enhanced and accelerated through the use of wood lath snow fencing. Two parallel rows of fencing were installed down the centre of the spit and have proven to be very effective in trapping wind blown sand. As a result of this method, the elevation of the spit has been raised about four feet (1.2 m) and has been sufficient to prevent high tides from washing over the spit and drastically altering it. The fencing has stabilized the sand to the degree where conditions are now favourable for the growth of new colonies which have become quite prolific on parts of the spit. (See Figure 9)

Many instances of sediment movement on the island have been noted, but few have been recorded. One such documented example shows the misconception of the term "stabilization" as applied to Sable Island. The heavily vegetated and considered stabilized dune ridge on the east end of the island has an elevation of approximately 65 feet (19.8 m). During the summer of 1963, the Canadian Hydrographic Service established a series of triangulation stations and benchmarks on the island. Figure 11 shows the site of one of the benchmarks at elevation 61.9 feet (18.9 m). This benchmark was established on the surface of the sand and well anchored. Eight years later in 1971, a search for the benchmark revealed that four feet (1.2 m) of sand had accumulated over the original sand surface. The accumulation of approximately one half foot (15 cm) per year at this elevation gives some indication of the amount of sediment being transported on the island by forces of the wind.

A second documented illustration of the amount of sediment being

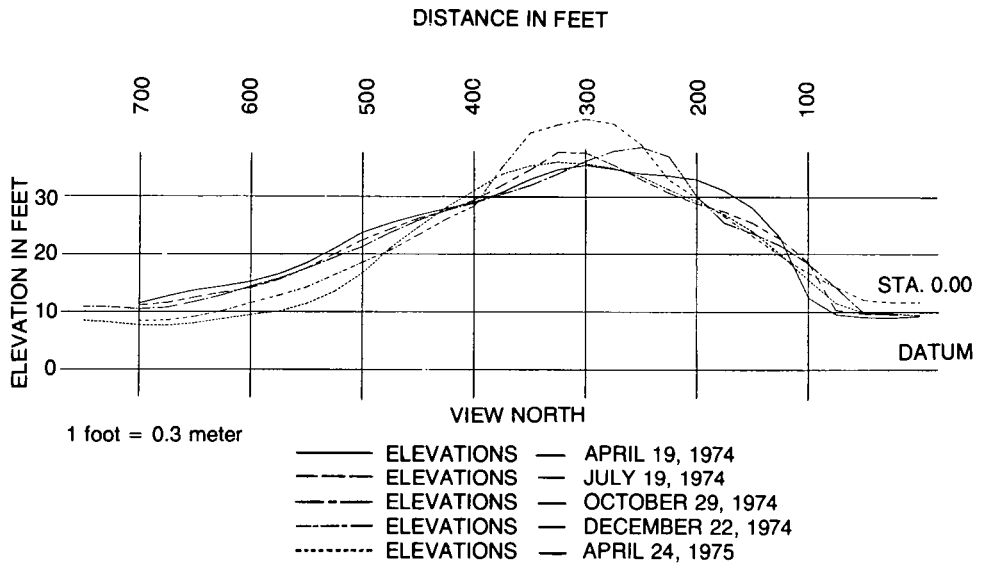

Figure 12. Profile GIT showing changes monitored between April 1974 and April 1975.

eroded is the disturbance of a benchmark established during the summer of 1963. A benchmark labelled "gas", was established in the same general area, but about 500 feet (153 m) south, near the edge of this dune system. During the winter of 1973-74, the benchmark was undercut by erosion of the face and later found at the bottom of the slope. This incident suggests a rapid rate of erosion in a north direction on the dune face. Considering these two documented cases relative to one another indicates that this particular dune system is increasing in elevation, but at the same time is decreasing in width.

A third documented case of sand movement by wind force is shown in the measurements of the bald dune southeast of East Light. This particular dune was monitored for a twelve month period from April 1974 to April 1975. A profile, referred to as GIT, was established along the centre line, or major axis, of the dune and the elevations were monitored at approximately four month intervals. Figure 12 shows the changing position and profile of this dune. All elevations are referred to a reference datum established on the beach. It is interesting to note from this diagram that the dune has actually migrated in an easterly direction over the twelve month period.

The fourth documented case where sediment transport has been considered significant is illustrated in Profile 4 taken near the center of the island. In this profile, which was monitored during the twelve month period from April, 1974 to April, 1975, both the profile and the width of the beach have undergone marked changes (see Figure 13). During this twelve month period the beach actually gained over 150 feet (45 m) in width. Although the control data is not sufficient to substantiate this view, it is felt by the writer that these changes were not mainly gradual or

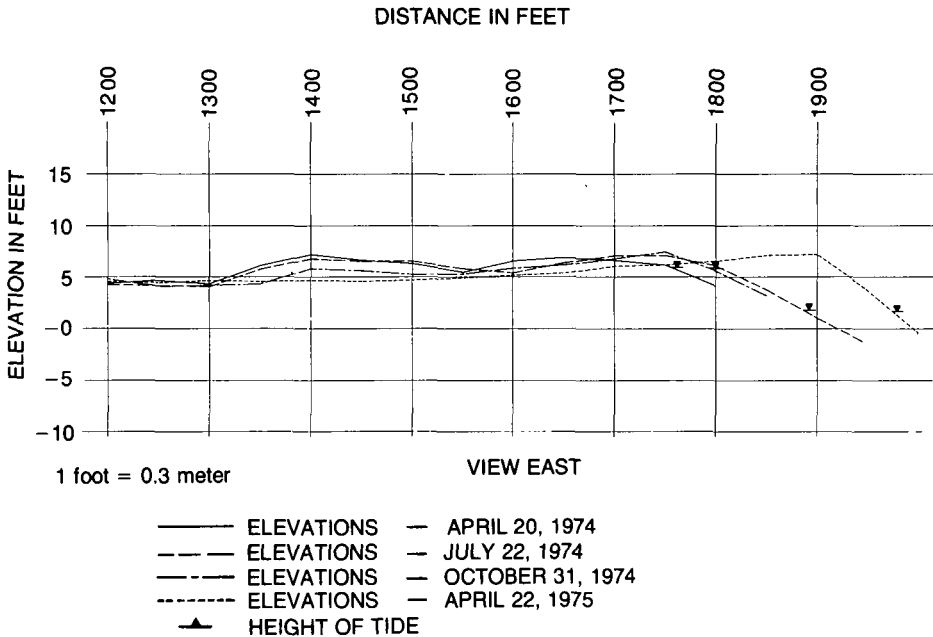

Figure 13. Profile 4 showing sediment movement during period April 1974 to April 1975.

accumulative. Rather, the changes seem to have occurred sporadically during short intervals of high seas and/or intense storm conditions.

The data referred to above lead to two tentative conclusions. The first point is that the wind blown sands on the dunes are being moved in a general easterly direction. This is supported by the analyses of the wind direction which show that the dominant winds are from the northwest and southwest. This could result in a sediment movement toward the northeast-southeast. This resultant eastward migration is reflected in the movement recorded at profile GIT. However, these conclusions cannot be taken as final because of the various other factors that have not been considered. For example, the very strong east-southeast component of wind during brief periods may in itself result in rather significant sediment transport.

A good deal has to be learned of the long shore currents and the tidal effects, as well as the combined atmospheric and ocean influences on the offshore migration, erosion, and sedimentation patterns on and around the island. It is generally considered that there is an equilibrium of sand movement from the island to the sea through wind action, and sand gain to the island through wave action. Determination of the long term trends and the net effect of this movement of sediment to and from the island would require a good deal of study. One documented case showing that large amounts of sediment are being transported in the offshore area deserves mentioning. At well Cohasset, the Mobil-Tetco well located in a trough about 5 miles (8.1 km) south of Sable, about 30 feet (9 m) of sand has accumulated over a period of two years, (personal communication with Mobil Oil of Canada Limited).

Little is known about the erosional forces and sediment transport on the island. It is widely recognized that erosion, sediment movement, and deposition are three problems that have to be dealt with by any operation, whether it be on the island or on the Sable Bank. These problems are very much a large part of every day life and a part of every program or project carried out in this environment. Several basic fundamentals of wind dynamics and barrier effects should also be understood and considered before any development is initiated on the island. For example, if an obstacle, whether it be a building, fence, or some other structure, is erected on the island, prior consideration should be given to the stability of the sands in the area of the structure, as well as to the effect the structure will have on the wind patterns in that immediate area. Bagnold (1949) has shown several fundamental sand features which result from minor obstacles that create a barrier to the wind. Any obstacle that reduces the velocity of sand laden wind will result in conditions that favour deposition of that sand around the obstacle and to the leeward side of it. Obstacles can also create a funnelling effect of the wind which actually increases the velocity and will cause erosion around the corners and extremities of such obstacles. These two factors alone give rise to continuously eroded and deposited sand which results in a good deal of maintenance and restoration work around man-made structures. Figure 14 shows diagrammatically three such conditions where sand erosion and deposition conditions result, because of barriers interfering with wind direction and velocity.

ENVIRONMENTAL GEOLOGY

The importance of proper management and the input that environmental geologists can have in environments such as Sable Island are directly related. Prudent development and efficient management of such an environment requires consideration of the physical factors of the earth materials and the environmental geology together with the water system, the flora and fauna, and the eco-systems that exist in harmony in this environment. Such development and management can be achieved only through a multi-disciplinary approach from engineers, geologists, biologists and those sincerely interested in management of man's total resources. Only when this is realized will the optimum benefits be derived from working in this type of environment.

Protection of Freshwater Reservoirs

The unique topography, geology, and groundwater regimen of the island all emphasize the need to wisely protect and develop the freshwater reservoir under the island. One of the main concerns of developing the freshwater lenses will be a matter of conservation. Development of such a freshwater lens should be done with a good deal of caution because of the very real danger of salt water intrusion. Continuous pumping should be at a minimum so as to reduce the risk of salt water encroachment. The establishment of monitoring wells should be considered and such wells placed between the pumping wells and the beach to monitor the movement of the freshwater-saltwater interface.

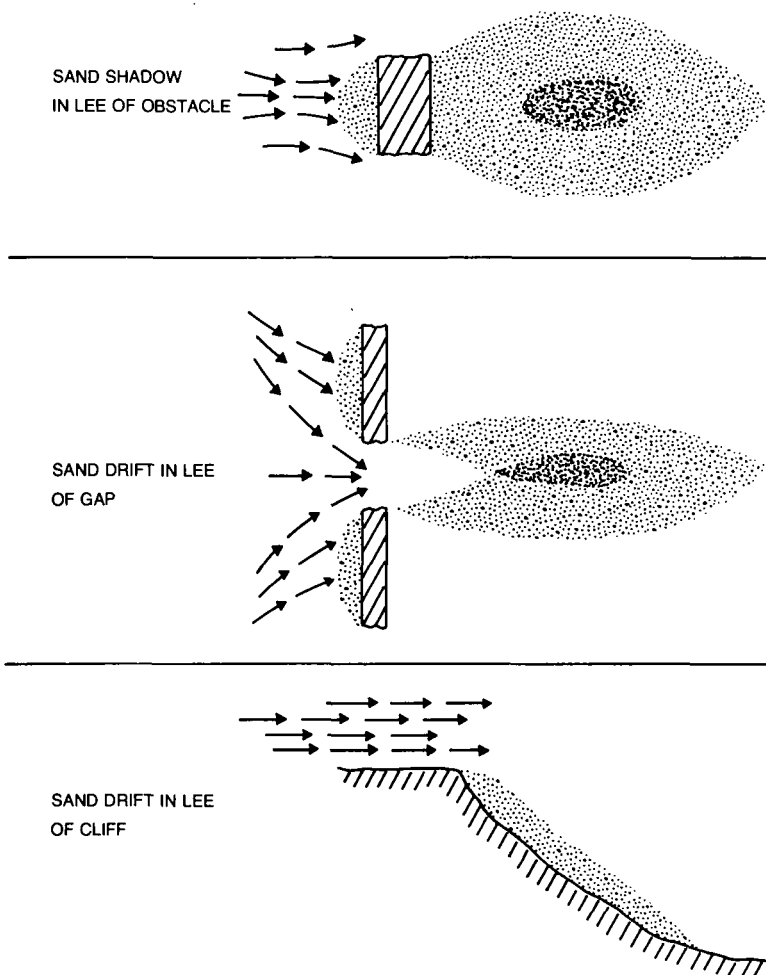

Figure 14. Diagrammatic illustrations showing three types of sand deposits and the cause of each

Another concern in protecting the freshwater reservoir is that of the disposal of solid and liquid wastes on the island. The absence of clay materials and the nearness of the water table to the surface, together with the high permeability of the sands, makes the freshwater lens extremely susceptible to contamination from the disposal of such wastes. Liquid wastes disposed on the island can readily infiltrate to the water table and then spread laterally through the upper zones to producing wells. Solid wastes disposed on the island will be readily attacked and dissolved by the abundance of low pH precipitation. The resulting leachate will be free to move vertically to the water table where it may move laterally through the sandy aquifer towards producing wells. The subsurface disposal of any liquid or solid waste should be minimized on the island. If it is necessary for this type of disposal on the island, it should be done near the beach zone or on the spits. The areas and basins between the two main dune systems in the centre of the island should be protected from the disposal of any kinds of wastes and reserved for future

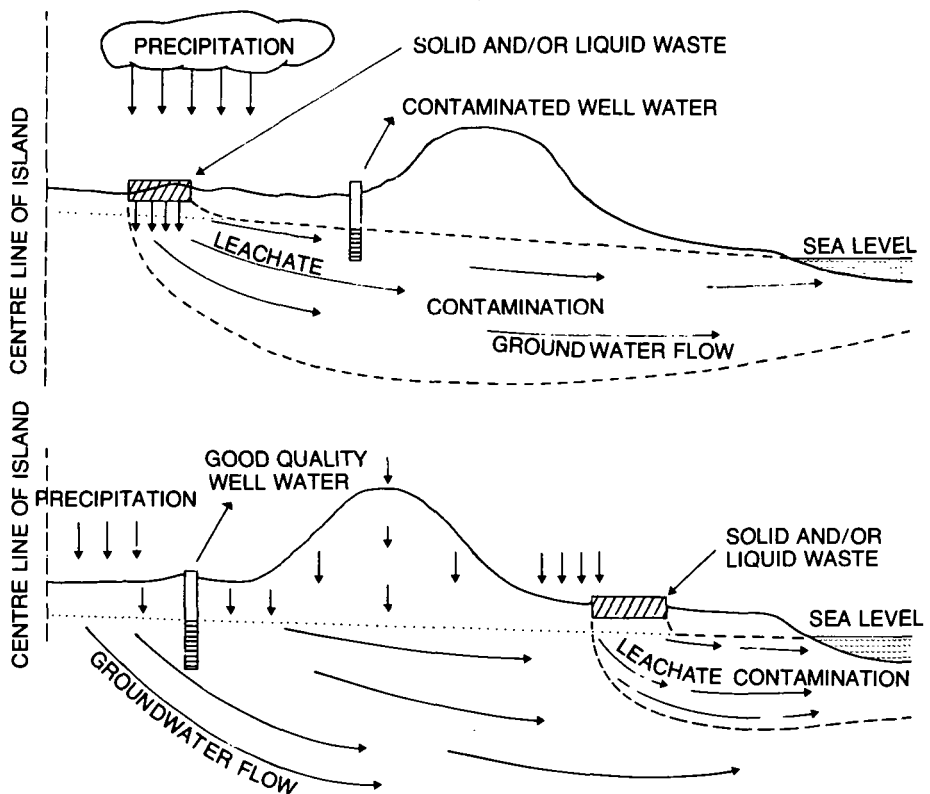

Figure 15. Generalized movement of groundwater and effect of waste disposal on well water.

freshwater development. Figure 15 shows generalized movement of groundwater under the island and the recommended locations for water wells and disposal sites.

Protection of Vegetative Cover

The stability of the topographic features and the terrain of the island are to some degree controlled by various types of vegetative cover. Areas where blowouts have occurred and where the terrain has been damaged may be partially repaired by proper use of obstacles that alter the wind patterns and change the sand erosion trends. One method of accumulating sediment that has been very effective on the island is the use of wood lath snow-fencing. The proper use of this fencing can cause the accumulation of large volumes of sands especially on the spits, in blowouts, and in areas where substantial amounts of sand are subject to movement. The use of snow-fencing should also be considered in areas where solid wastes have been disposed of. In these areas fencing can be applied to increase the amount of sand over the debris and to prevent the removal of sand from such sites. Once the sand has been stabilized by fencing, efforts should be made to encourage vegetation. Limiting the horse and vehicular traffic on vegetated areas is also necessary to control erosion. Many of the existing blowouts on the island have been triggered by the effects of this type of traffic in sensitive areas.

WATER RESOURCES

INTRODUCTION

The freshwater resources of Sable Island are contained in either ponds or in groundwater that underlies the main part of the island. Because of the extremely high infiltration capacity of the sands, none of the precipitation runs off as streamflow. Field measurements of infiltration rate range in the order of 70 to 90 inches (178 to 228 cm) per hour, greatly exceeding the largest rainfall intensity recorded on the island. Therefore, most of the water which falls as precipitation is available as direct recharge to the groundwater reservoir.

SURFACE WATER

Of the many freshwater ponds on the island, most are shallow and their natural reservoir capacity varies considerably with seasonal fluctuations. The shallow nature of these ponds, and the high organic content of the bottoms and shores contributes to a water quality that is often unsuitable for domestic or industrial uses. The wildlife populations inhabiting these waters further deteriorate the quality. Only a few of the freshwater ponds are of any significant size and contain reasonably good quality water. In these few there is a dependable small supply during dry summer periods. The chemical analyses listed in Appendix E outline the water quality of one such pond, located west of Old No. 3 at UTM, location 672,682. Another pond is located between the West Light and the main weather station between the north and south dunes. The water level in these ponds fluctuates in the order of 3 to 4 feet (0.9 to 1.2 m) a year. The depth is about 5 to 10 feet (1.5 to 3.0 m). They are well protected from intruding salt water from high tides by the bordering dune barriers.

All of the other fresh water bodies on the island are small depressions in the sand that have been scoured below the high water table mark. These ponds, therefore, only have a useful reservoir during periods of high water stage. During the summer months, when the water table falls, most of the ponds become dry. These areas are quite small in areal extent and usually are used as waterholes by the horse population.

GROUNDWATER

The groundwater reservoir existing under Sable Island occurs as an unconfined system which extends the entire length of the island. The water table is generally flat with a slight concave geometry and a slope from the center to each shore. The gradient from the centre of the island to the beach is in the order of 1 to 2 feet (0.3 to 0.6 m). The presence of freshwater under the island and its relationship to the surrounding and deep lying salt water follows the general Ghyben-Herzberg relation. This relationship expresses the hydrostatic conditions of a freshwater head above sea level and the resulting depth of freshwater below sea level in an aquifer. This relationship is described by the equation:

$$H_s = \frac{P_f}{P_s - P_f} \times H_f$$

Where H_f is the freshwater head above sea level, H_s is the depth to the salt water interface below sea level, P_s is the density of sea water taken as 1.025, P_f is the density of freshwater taken as 1.000. This situation is shown in a diagrammatic sketch as illustrated in Figure 16.

To give some indication of how closely the actual conditions on Sable follow this rule, several test wells were drilled on the island at various depths from which water samples could be collected, and measurements of the freshwater head could be obtained. These test holes were drilled in two main profiles as shown in Figures 17 and 18. The profiles show the topography, the location of test holes, and interpretations of the freshwater-saltwater interface. Profile 1 (Figure 18) is near the main station, and Profile 2 (Figure 17) is about two miles (3.2 km) east of Old No. 3. A geophysical survey using electrical soundings was carried out on the island during the summer of 1973 with the objective of delineating the freshwater lens.

Thirty-nine soundings of the Schlumberger configuration were executed in profiles perpendicular to the shores of the island. The resulting field curves displayed three-layer earth models corresponding to unsaturated sand, fresh water saturated sand, salt water saturated sand. In areas where the diffusion zone between the salt and fresh water was sufficiently thick to influence the shape of the resistivity curve, a four-layer earth model was displayed (Lazreg, 1974). The field curves were interpreted by curve matching techniques using theoretically calculated sets of master curves in conjunction with auxiliary point diagrams and computer control (Lazreg, 1974).

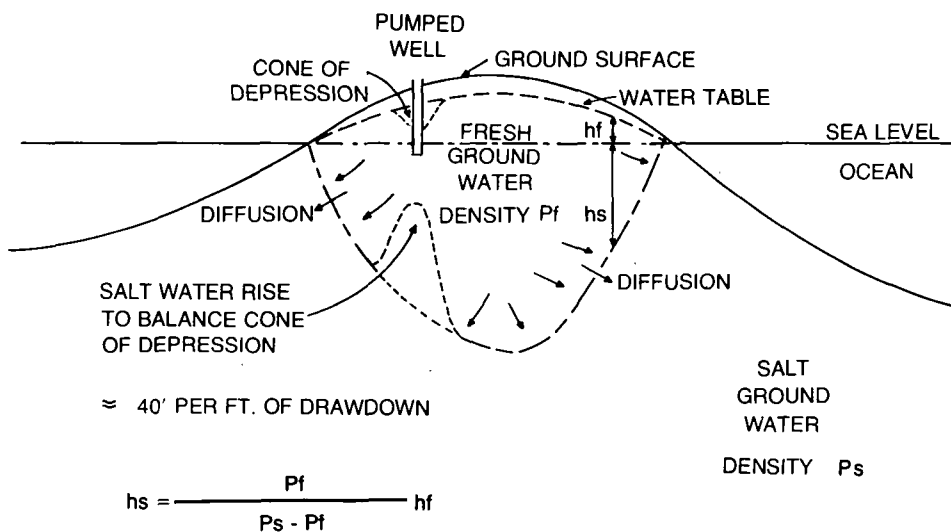

Figure 16. Idealized cross section showing a freshwater lens under an island, based on the Ghyben-Herzberg relation.

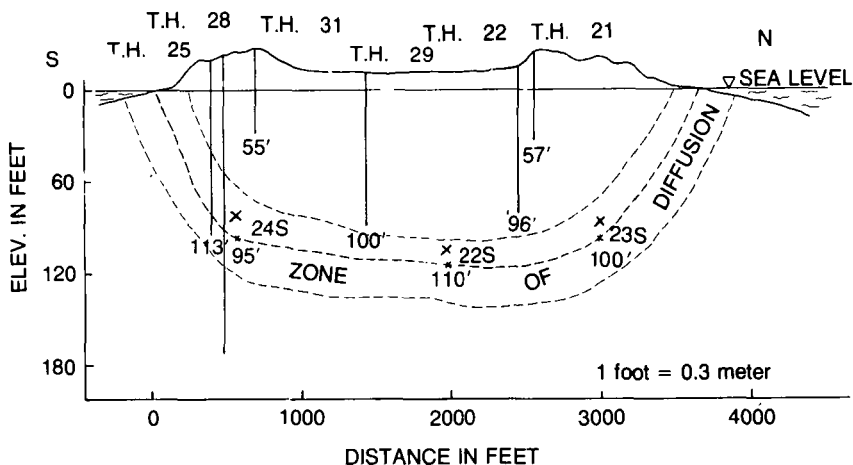

Figure 17. Section along profile 2 showing approximate dimensions of the freshwater reservoir.

In addition, the soundings were carried out near control points where chemistry data of groundwater were available for correlation. The formation resistivity in which brackish water occurs was taken to begin at 200 ohms per meter. Areas where resistivity values of less than this were recorded will be referred to as the beginning of the zone of diffusion.

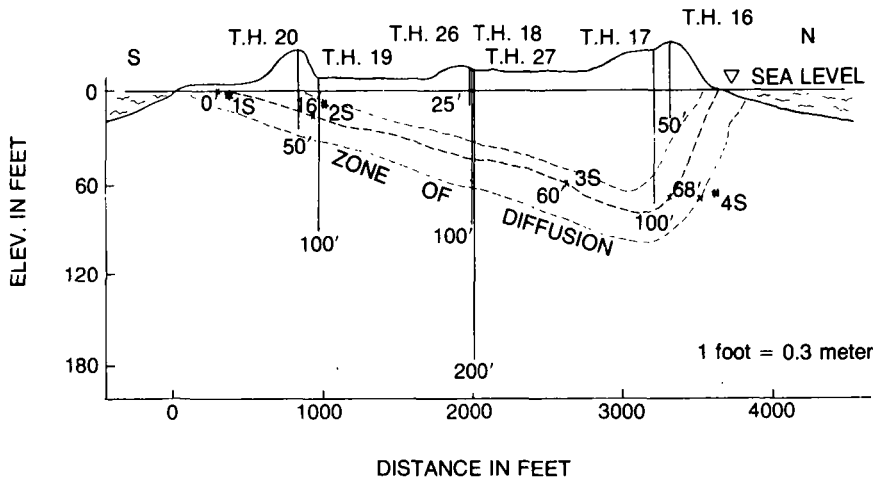

Figure 18. Section along profile 1 showing approximate dimensions of the freshwater reservoir.

From these data, the depth of freshwater in the lens varies from less than a foot (.3 m) to about 120 feet (36 m). This also agrees reasonably well with what one would expect from using the Ghyben-Herzberg relation and applying the freshwater head as determined from the hydrograph data. However, the most significant contribution of the resistivity survey is that an appreciation of the geometry of the lens can be formulated through the interpretation. In Profile 2 (Figure 17) the lens

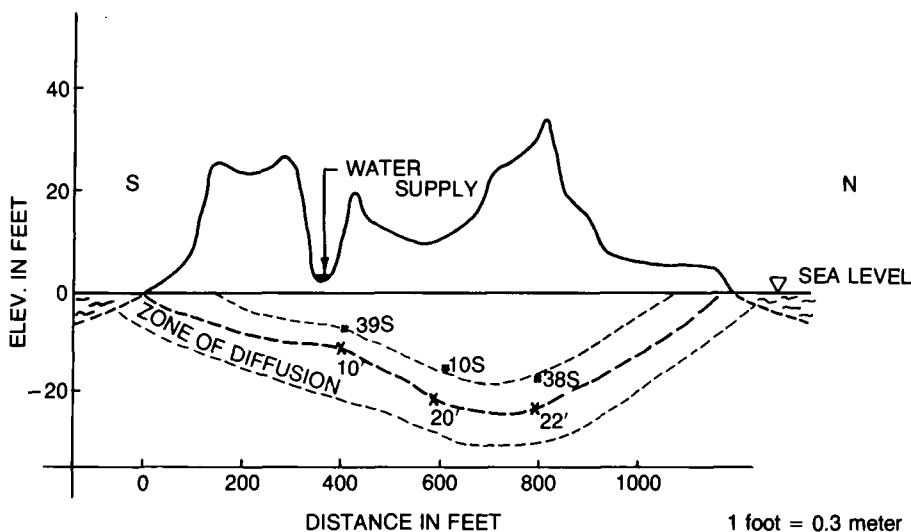

Figure 19. Section along profile 3 showing approximate dimensions of the freshwater reservoir.

appears to be relatively stable in an area where the island is wide, there are no pumping stresses and the lens is protected on both the south side and the north side by a dune barrier. This area is in the east half of the island where no development has occurred to date. However, in Profile 1 (Figure 18) taken near the main station, the depth of the freshwater lens is quite distorted, being very shallow on the south side and deepening towards the north beach, where the depth is what one would expect using the freshwater heads in test hole 17.

The reasons for this asymmetric shape in Profile 1 may be explained in part by the following:

1. This could be reflecting a long term salt water intrusion effect from development of the Main Station and West Light area. This is the only area on the island in which any water usage has occurred on a continuing basis for a lengthy period of time.

2. The topography immediately to the west and to the east of the site could be an influence. The west part is flat lying and subject to flooding from salt water during storms and during the winter. The re-entrant from the south, immediately west of the light also floods, thus dissecting the freshwater lens. The same conditions occur just east of this profile on the beach at the west end of Lake Wallace. Salt water flows over the beach to the base of the dunes at this point quite regularly. The fact that the salt water boundary is that much closer to the center of pumping should have a more pronounced effect in encouraging intrusion.

The cross-section along Profile 3 (Figure 19) also shows lateral salt water wedging and upconing underneath the pumping well at Mobil Oil Base Camp. At this site, the freshwater lens should be more symmetrical because of the topography and well defined basin in which water infiltrates to the groundwater reservoir. However, the geophysical data,

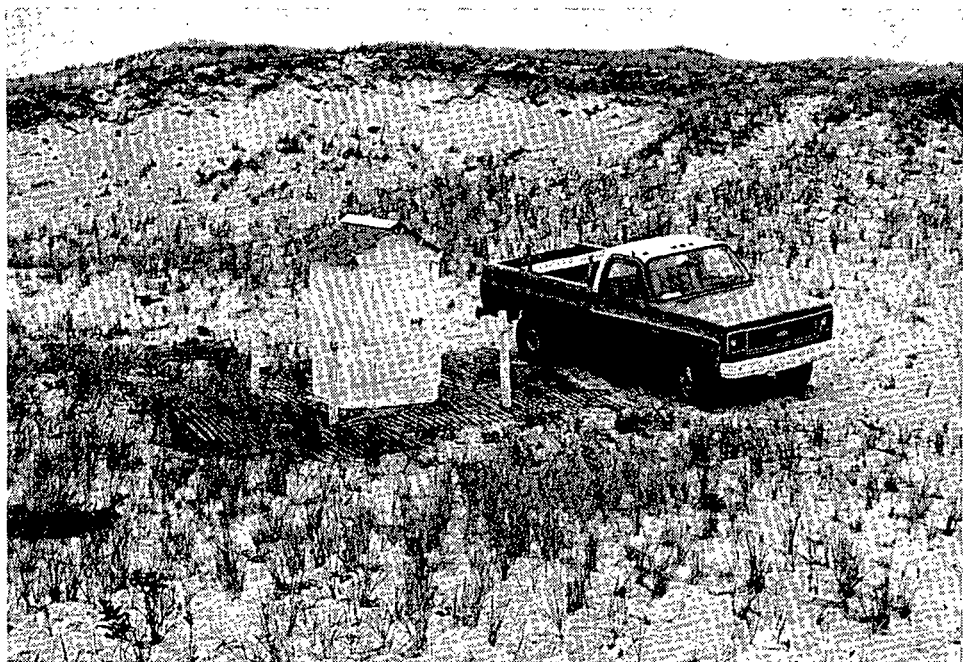

Figure 20. Location of observation well 47 near center of island.

as well as the chemical analyses, support that there has been in fact lateral intrusion and/or upconing at this site. Also, water quality monitoring of this well over a two year period from May 1972 to June, 1974 indicates a higher than normal chloride background. A further discussion of these results is found in the section on Water Quality.

The hydrographs recorded in the various observation wells show several interesting characteristics. Appendices A, B, and C, show the annual hydrographs for the wells that have been instrumented. The cyclical trends in all wells indicate high water level stages during November to February and low water level stages during August to October of each year. In observation well 47 (Figure 20) for example, the water level peaked at 4.5 feet (1.37 m) above chart datum during February. The water level reached its low point of 2.9 feet (0.88 m) above chart datum in early August. This low value is very significant because of the influence of the head on the freshwater - saltwater interface. Since mean sea level is only 3.3 feet (1.01 m) above chart datum, then during this period of low water the level is actually 0.4 feet (0.1 m) below mean sea level for short periods of time.

Figure 21 shows the rapid response of the water level, in observation well 47, to recharge from precipitation. In this case 1.19 inches (3.0 cm) of precipitation resulted in a 0.24 foot (0.07 m) response to the water table. However, this response ratio was highly variable for other storms throughout the year. Table 3 shows some of the data for part of the year 1973 as observed in well 47. The response over precipitation ratio varies from 0.95 to 21.00. Some of the factors contributing to this

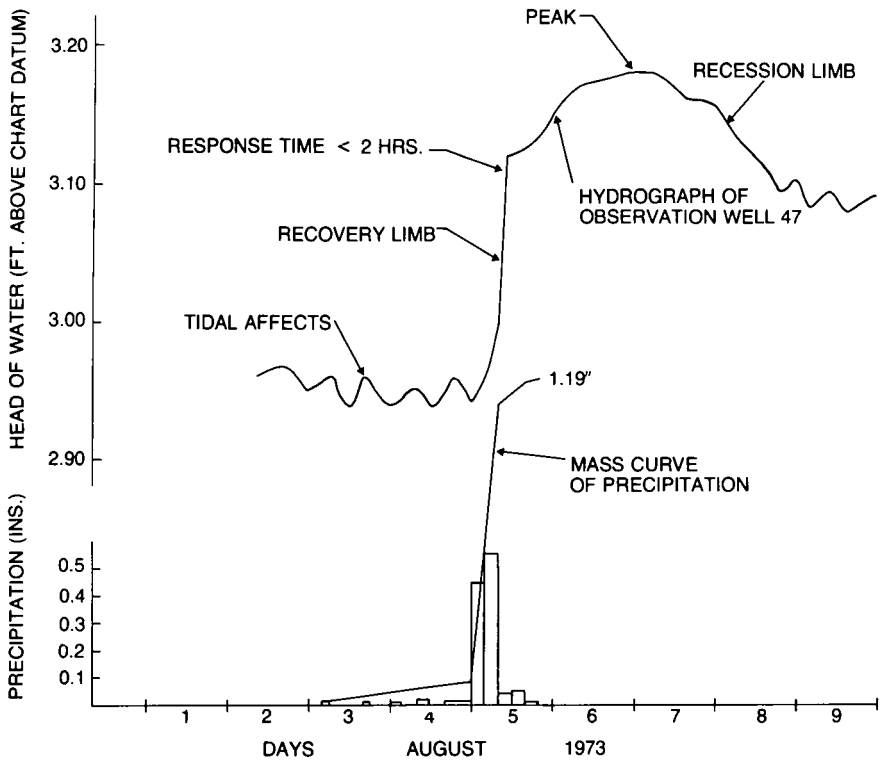

Figure 21. Response of water table to recharge from precipitation in observation well 47.

Table 3. Hydrograph data from observation well 47.

Date	Inches Precipitation	Water Level	
		Inches Response	Response/Precip.
13 June 73	4.35	11.76	2.70
6 July 73	0.12	2.52	21.00
11 July 73	0.41	0.96	2.33
17 July 73	0.88	0.84	0.96
21 July 73	0.56	0.72	1.29
27 July 73	0.45	0.48	1.07
3 Aug. 73	1.19	3.00	2.52
10 Aug. 73	0.36	0.60	1.67
22 Aug. 73	1.23	2.51	2.04
28 Aug. 73	0.23	0.72	3.13
26 Oct. 73	2.07	7.20	3.48

variability include: 1. changing soil moisture values, 2. rainfall intensity variations, 3. differences in actual rainfall between the recording station and the well site, and 4. water stored on the surface, i.e. in form of a snow pack.

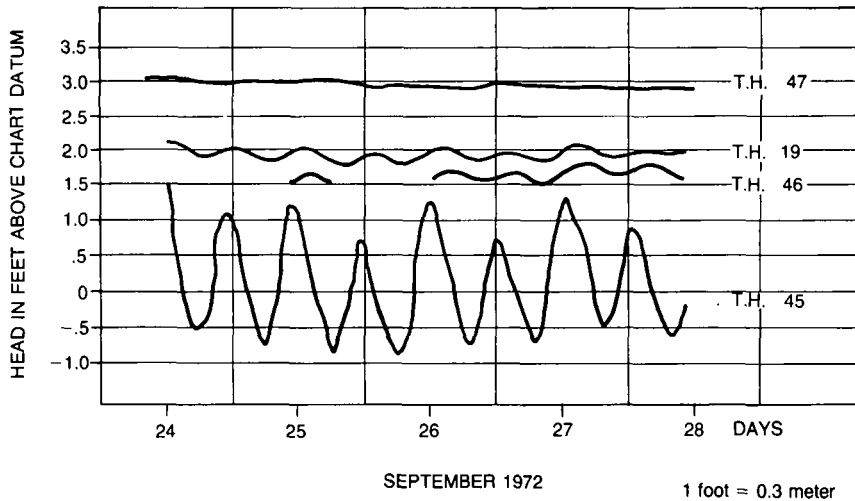

Figure 22. Plot of hydrographs from wells located at various distances from the shoreline.

Tidal Effects

The types of tides on Sable Island are semi-diurnal. There are two complete tidal oscillations daily, both high waters having similar heights, as well as both low waters. The two high waters of the day follow the upper and lower transits of the moon by nearly the same interval. The amplitudes of these tides on the island range from 3.7 feet (1.1 m), for a mean tide, to 5.3 feet (1.6 m) for a large tide (Canadian Hydrographic Services, 1975).

The predicted tide levels are of a tidal oscillation or rise and fall above and below the mean level of the sea. Meteorological conditions, such as strong or prolonged winds, abrupt changes in barometric pressure, or prolonged periods of very high or very low pressures, introduce fluctuations in the mean level of the sea. The high and low water heights which actually occur are the result of the predictable tidal oscillations together with fluctuations of meteorological origin which cannot be forecast in advance (Canadian Hydrographic Service, 1975).

A series of test wells were drilled and instrumented to monitor the effect of the tidal fluctuations on the freshwater head. The data collected indicated that this changing head was transmitted through the aquifer to a distance inland of approximately 1,000 feet (300 m). Figure 22 shows a plot of four hydrographs recorded during the period of September 24-28, 1972. Test hole 45 was located on the beach about 10 feet (3 m) above the high tide mark. The well consisted of a 6 inch (15.24 cm) diameter casing washed into the sand to a depth of approximately 15 feet (4.5 m). The dampening effect of this distance from the ocean was quite significant. Test hole 46 drilled to 15 feet (4.5 m) and located 100 feet (30 m) inland from test hole 45 also shows a marked decrease in the tidal fluctuations. Test hole 47 at the centre of the island a distance of about 2,000 feet (600 m) from the shore, appears to be unaffected by these tidal fluctuations.

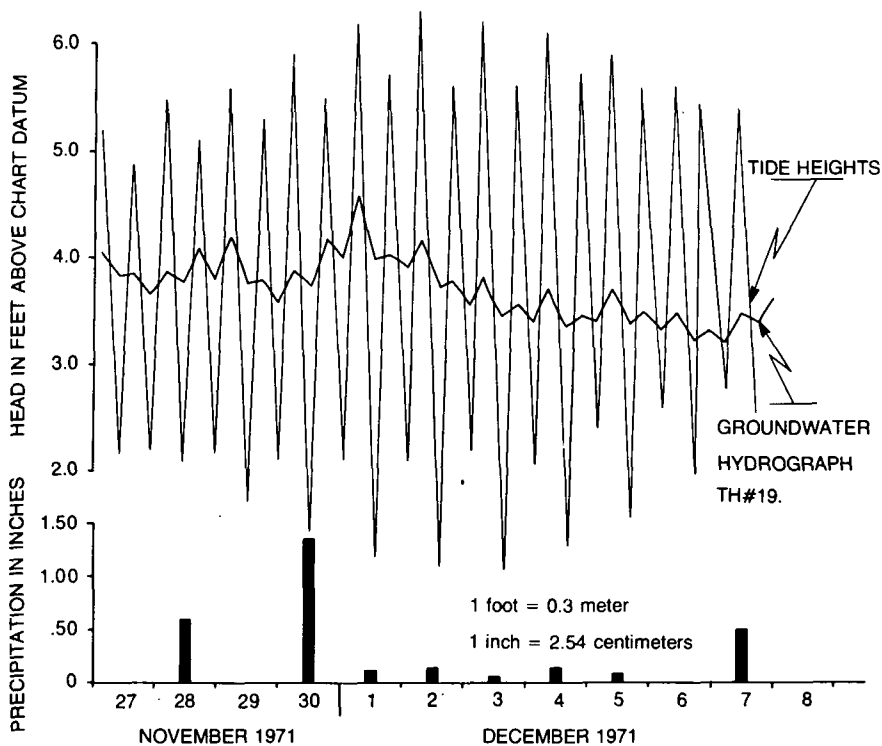

Figure 23. Plot of groundwater hydrograph from test hole 19, predicted tide levels, and precipitation.

Figure 23 shows a plot of the hydrograph from test hole 19 together with the predicted tide levels and the precipitation during late November and early December, 1971. It is interesting to note that the groundwater fluctuations are completely in phase with the tidal fluctuations. The groundwater peaks and troughs coincide with those of the tidal stage. Superimposed on the tidal effect of the groundwater hydrograph is the recharge influence of significant amounts of precipitation. The relatively large amounts of precipitation recorded on November 28 and 30 produce very noticeable recharge effects on the reservoir.

As a result of this tidal influence, the freshwater lens as outlined in the preceding discussion is not continuous from the east end of the island to the west end. In several areas of the island where the topography is low, salt water has flooded the surface. The freshwater lens has been breached and therefore is dissected by slugs of vertically infiltrating salt water. As a rule of thumb, it may be safe to assume that a freshwater reservoir occurs beneath any topographical area on the island that has a significant area completely surrounded by a dune system. Also, from water level measurements obtained from within such a basin, a reasonably good estimate can be obtained of the thickness of the freshwater lens in that area. These head changes resulting from the rise and fall of the tide will have significant effects on the zone of diffusion, especially along the shore. It is suggested that a good deal of mixing

occurs because of these changes, and, therefore, the zone of diffusion would be much wider in these areas. Also, an effect that is not easy to document is that of storms and high seas flooding the beach to create a sheet of salt water as a source of recharge that infiltrates vertically to the aquifer.

Well Yields

Two areas were selected on the island where the permeability of the sands was determined by field methods. Test hole 39 located at UTM 568687 and test hole 41 located at UTM 708687 were constructed for the purpose of conducting pumping tests.

At the site of test hole 39, a stainless steel well screen, 1.5 inch (3.81 cm) diameter, 10 slot, three feet (.9 m) long was washed in to a depth of 13 feet (3.9 m). Two observation wells, 36 and 38, were washed in to depths of 18 feet (5.4 m). Well 38 was located at a distance of about 1 foot (.3 m) from the pumping well, and well 36 was about 86 feet (25.2 m) from the pumping well. On August 1, 1972, a pumping test was conducted on the well at a rate of 25 igpm (113.7 lpm) for a duration of 8 hours. At the end of the test period, the drawdown in observation well 38 was 2.71 feet (.81 m) and the drawdown in observation well 36 was 0.18 feet (5.4 cm). Using these data, the transmissibility for the sand formation in this area was estimated to range from 30,000 to 46,000 igpd/ft. (447,000 to 685,400 lpd/m). The storage coefficient as determined from the same data was estimated to be 0.05.

Test hole 41 is located in the central part of the island about two miles east of Old No. 3. For this pumping well, a 1.5 inch (3.81 cm) diameter, 3 feet (91.5 cm) long, 10 slot stainless steel well screen was washed in to a depth of 14 feet (4.2 m). Three observation wells were used to record the water level changes during the pumping test. Observation well 44 was washed to a depth of 14 feet (4.2 m) at a distance of less than 1 foot (.3 m) from the pumping well. Observation well 43 was washed in to a depth of 13 feet (4 m) about 9 feet (3 m) from the pumping well. Observation well 30 was drilled to a depth of 56 feet (17.1 m) about 18 feet (5.5 m) from the pumping well and was equipped with 4 inch (10.16 cm) diameter casing and a 2 inch (5.08 cm), 20 slot, 3 feet (90 cm) long well screen. On September 12, 1972, test hole 41 was pumped at a rate of about 25 igpm (113.71 lpm) for a duration of 12 hours. At the end of this test period, the drawdown in observation well 44 totaled 2.3 feet (70.15 cm). In observation well 30, the drawdown was one foot (30 cm) and in observation well 43 the drawdown was 0.67 foot (20.43 cm). Using these drawdown data and the pumping rate of 25 igpm (113.71 lpm) the estimated transmissibility varied from 16,000 to 33,000 igpd/ft. (238,400 to 491,700 lpd/m). The storage coefficient as determined from these data varied from 0.02 and 0.04. The mean transmissibility of the sands at this site can be estimated as 31,000 igpd/ft. (461,900 lpd/m.) and the mean storage coefficient as 0.03.

In several other areas, where a supply of water was required, adequate supplies could be obtained through proper use of small

diameter, self-jetting well screens. In areas where the depth of the water table from the ground surface is less than 10 feet (3 m) the use of these well screens provides a readily accessible source of water. Where these screens were installed for field purposes, a common yield of 20 to 25 gpm (91 to 114 lpm) was obtained without any difficulty using a 3 hp, portable, centrifugal pump.

On the basis of the pumping tests described above, it can be safely stated that sufficient volumes of water can be obtained readily from the island sands, using this type of well construction. However, if the quality of water required is of concern, as it would be for developing a domestic supply, then very careful consideration should be given to the site chosen for development of such a groundwater supply. Because of the high permeability and storage coefficient of the sands, well depths need not be any greater than that required to assure about 10 feet (3 m) of saturated thickness or 10 feet (3 m) of total available drawdown. Also, sites selected should be at a maximum distance from the seashore and in areas protected by the dunes from the lateral migration of tidal water intruding into the central part of the island.

FRESHWATER BALANCE OF THE ISLAND

A crude estimate of the freshwater balance of this island environment can be made using existing data. For this particular situation, the general hydrologic equation can be used to determine the net balance of freshwater on the island. Balancing this equation requires equating inflow with outflow plus or minus net change in storage.

Examination of the hydrographs (Appendices A,B,C,) indicate that the water stage fluctuates considerably during the year, but at any given normal season the head is not significantly different. Therefore, the equation can be simplified to include inflow as balanced against outflow. On this specific island, the total amount of inflow to the freshwater reservoir is from precipitation. The area to be considered as usable reservoir would have to be determined from existing maps and known flood levels. The areas of flat beach, and where salt water is known to flood the island, cannot be considered as usable reservoir. On the basis of the existing topography map, use of air photos, and recorded flood levels, an area of approximately 5,000 acres (2,025 ha) of the island can be considered as reservoir area.

Using the mean annual total precipitation of 50 inches (127 cm) for the island, the inflow or total freshwater recharge to the reservoir annually is in the order of 20,800 acre-feet (25,369,760 m³). It must be considered, however, that this value varies significantly from about 9,000 to about 27,300 acre-feet (10,977,300 to 33,297,810 m³) annually and is entirely dependent on precipitation patterns on the island.

The main outflow factors to be considered in balancing this equation would be 1) actual evapotranspiration, 2) groundwater discharge to the sea, and 3) water consumption or water pumped by man.

Under the present level of development of the island water consumption may be considered negligible. Based on a local permanent population of fifteen and a daily consumption of 100 gallons (455 l) per day per person, the annual water use is only about 2 acre-feet (2,440 m³). If the estimates of water loss through evapotranspiration and groundwater discharge to the sea can be determined, then the difference of that sum and the mean annual recharge should be an approximation of the safe yield.

The estimate of evapotranspiration on the island was done using the POTEV Program (Freeze, 1968), which utilizes the Thornthwaite and Penman Methods and the Holmes and Robertson Moisture Budget Technique for determining actual evapotranspiration of an area. The variables of temperature, precipitation, several other meteorological variables and constants, and factors for soil moisture are built into the program. The estimated evapotranspiration on a mean annual basis for Sable Island, using POTEV was 38 percent of the total precipitation which amounts to a mean annual value of 7,900 acre-feet (9,635,630 m³).

The annual groundwater discharge to the sea is a much more difficult variable to assess. However, the amount of groundwater loss to the sea would be a function of the permeability of the sands, the hydrologic head of the freshwater aquifer as well as the length of shoreline through which freshwater flows.

Using these variables, a freshwater head as determined from the hydrograph data and transmissibility as determined from the pumping test data and the length of shoreline of the island, the value for groundwater discharge is estimated to be in the order of 8,000 acre-feet (9,757,600 m³) per year. This gives a total mean annual loss of freshwater in the order of 15,900 acre-feet (19,393,230 m³) or about 75 percent of the total freshwater available.

It should also be considered that the type of water use as well as the schedule of pumping could very well affect the freshwater balance. For example, if large volumes are pumped from the aquifers and discharged directly to the sea, then a maximum stress will be placed on the system. However, if the water is withdrawn from the reservoir, used for cooling or irrigation, and returned as recharge, then a minimum stress will be placed on the reservoir. Pumping during periods of high freshwater heads will further reduce losses as discharge to the sea minimize intrusion effects.

WATER QUALITY

INTRODUCTION

A water sampling program was carried out during the study and both surface water and groundwater samples were collected. A total of eighty-four water samples collected from 41 different sites, were analyzed at the chemistry lab for dissolved mineral content. Twelve samples of surface water were taken from eleven different ponds, lakes or water holes. Also, seventy-two samples of groundwater were collected from thirty different wells. The analyses reported of these water samples are listed in Appendix E.

The results of these chemical analyses were plotted on a piper trilinear diagram to show the general chemistry classification of both the surface and groundwaters. Figure 24 shows the trilinear plot of these data. The surface water plots indicate that the water is strongly sodium, potassium, and chloride water with a deficiency in calcium, sulfate, carbonate, and bi-carbonate. This plot also shows that the groundwater chemistry is basically very similar. The grouping of samples on the diagram indicate a reasonable consistency in the overall quality.

Surface Water

It is interesting to note that the general quality of the surface

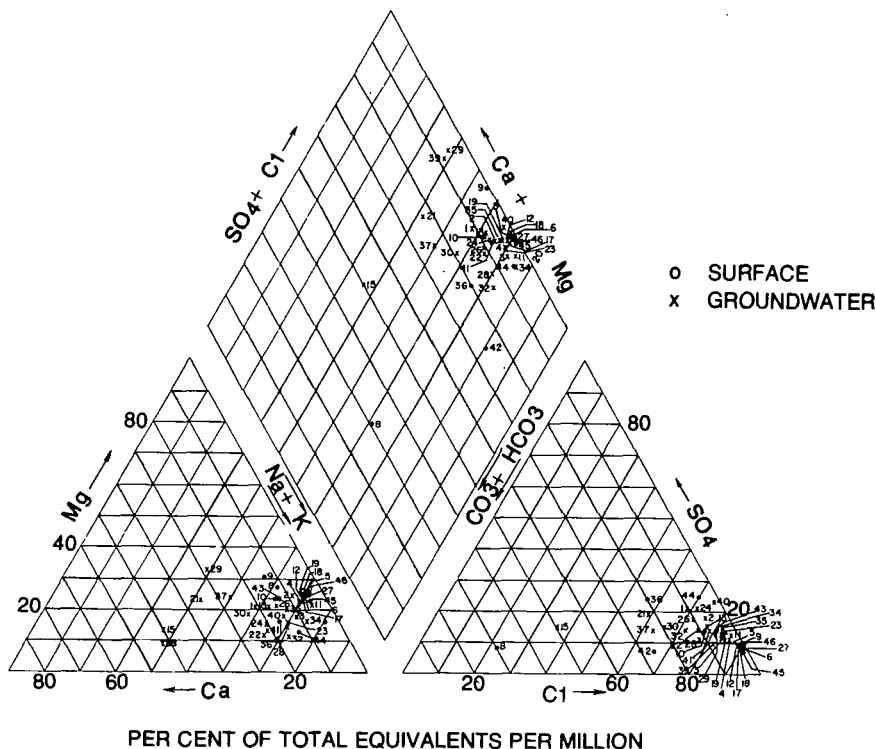

Figure 24. Trilinear plot of chemical analyses of water samples collected on Sable Island.

water varies considerably, depending on the proximity of the source to the ocean. For example, total dissolved solids (tds) of the surface water samples vary from about 78 to over 34,000 parts per million (ppm). These high values for tds in ponds can be partly explained by the following: 1) the ponds occur near breeches in the dunes where high tides have flooded that portion of the island, and 2) samples collected at the end of the summer period, when evaporation normally exceeds precipitation, may reflect a considerable amount of salt concentration in the shallow ponds. The tds value for the sample collected from Lake Wallace is 27,476 ppm. This value is probably slightly less than what might be expected from the ocean because of the continuous flooding of Lake Wallace by storms and also the regular mixing of the lake water with precipitation. It is also interesting to note that of the chloride values for the ponds the highest value of 16,500 ppm is in the pond located at UTM 686 680 near Old No. 3 life station. This chloride value compares to 13,200 ppm for the sample collected from Lake Wallace.

The water quality in the ponds that are protected from salt water intrusion and that are located in the central part of the island is reasonably good. The tds values of these ponds range from about 78 to 200 ppm. The chloride values range from about 11 to 80 ppm. There is a very sharp contrast in the pH of the waters in these two types of ponds. The ponds that are periodically flooded by sea water have a pH normally greater than 8.0, whereas the pH of the water in the protective ponds varies from 4.4 to 6.8.

Groundwater

Most of the groundwater samples were collected from newly constructed wells at various locations on the island. Depths range from about 5 feet (1.5 m) to over 100 feet (30 m) below ground level. Several of these sampling points were used as monitoring stations where samples were collected at regular intervals over a period of two years. The data in Appendix E shows the variations in quality for the four main monitoring sites; the Atmospheric Environment Services (AES) main station, West Light, Department of Mines Base camp, and the Mobil camp.

At the AES site, nine samples were collected during the period from May, 1972 to August, 1974. The pH varied from about 5.2 to 6.9 and the chloride values varied from 26 to 52. The mean pH for this station is 5.6 and the mean chloride value is 35.9 ppm.

At the Department of Mines Base camp well, seven water samples were collected during the period August, 1973 to September, 1974. During that period, the pH values varied from 5.4 to 6.1 and the chloride values varied from 54 ppm to 220 ppm. The average values of pH and chloride for this period are 5.8 and 83.2 ppm respectively.

Six water samples were collected from the Mobil Camp well between November, 1972 and June, 1974. During that period, the pH varied from 4.8 to 5.8 and the chloride values ranged from 90 ppm to 144 ppm. The average values are 5.2 for pH and 121.6 ppm for chloride.

Five samples were collected from a domestic well at West Light

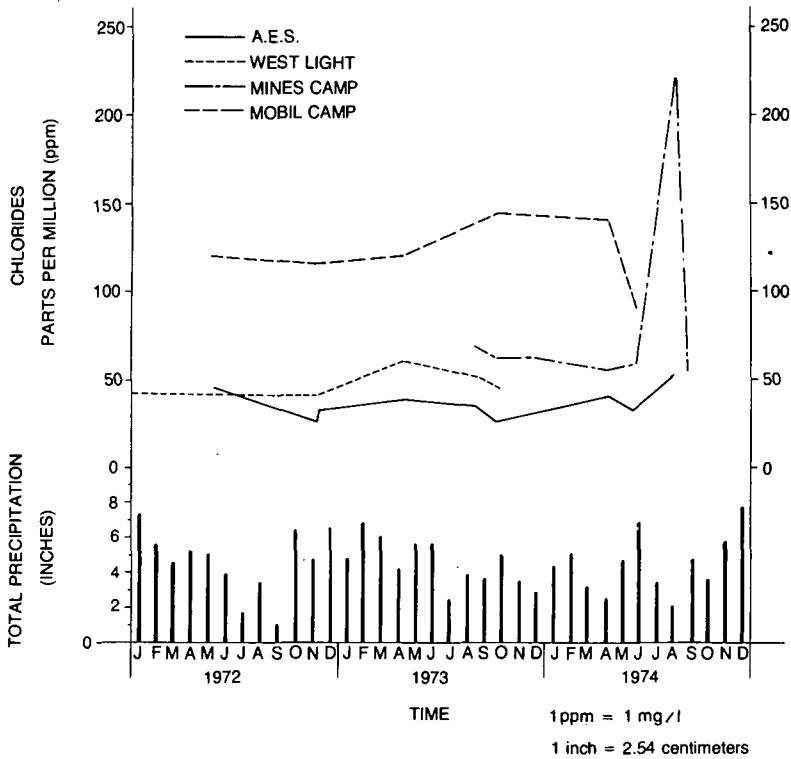

Figure 25. Plot of chlorides with time of four wells monitored on Sable Island.

during the period August, 1971 to October, 1973. During this period, the pH varied from 4.9 to 6.4 ppm and the chloride values ranged from 40 to 60 ppm. The average values are 5.5 for pH and 48.3 ppm for chlorides.

The nitrate values for the AES well during the sample period varied from 0.2 ppm to 2.9 ppm, with an average of 2.0 ppm. At the Mines Camp well, the nitrate values varied from 1.4 to 7.8 ppm during the period and averaged about 4.8 ppm. At the Mobil Camp well, the nitrate values varied from 1.2 to 5.3 ppm and averaged 2.9 ppm during the sampling period.

Water samples were also collected at regular intervals at these monitoring stations, and analyzed for bacteriological content. Of the total samples collected, none indicated coliform bacteria content greater than 5 coliforms per hundred milliliters of sample.

Figure 25 shows a plot of the chloride values for the four wells monitored from January, 1972 until August, 1974. From these data it is apparent that the chloride background increases steadily from the AES well to the Mobil camp well. This general increase, in a westerly direction, is to a large extent a function of the distance of the well from the beach or flooded portion of the island. The sudden and dramatic changes in chloride levels can be accounted for by the varying pumping rates and the available amounts of recharge from precipitation. For

example, the very prominent peak at the Department of Mines camp well can be accounted for by the increase in water usage during the summer field season which coincided with a time when precipitation was below normal. The chloride level declined sharply after the camp was out of use for a short time. During this period the fresh water head had a chance for recovery and replenishment from increased precipitation. Also, the relatively high chloride level of the Mobil camp well shows a dramatic decline after May, 1974 when the camp was disbanded and no more groundwater withdrawn. At both these sites the water supplies were developed in groundwater reservoirs with very limited fresh water heads.

Deterioration of water quality in this environment can be expected from three different sources. First, salt water may enter the freshwater aquifer by upconing. For wells that are constructed deeper than necessary in many parts of the freshwater lens salt may first enter the well as a result of upconing. Second, water migrating laterally through the sands into the freshwater lens as a result of pumping stresses may also cause salt water intrusion. Wells located near the perimeter of the freshwater lens would be more subjected to this type of contamination. The third type of water quality deterioration would be salt water encroachment onto the freshwater reservoir by flooding. This occurs in areas where the beach and topography are low enough to allow high tides to flood the low parts of the island. The salt water flows overland into depressions between the dunes where it infiltrates and mixes with the freshwater. Locating wells in areas subject to this type of flooding should be avoided.

SUMMARY AND CONCLUSIONS

Sable Island has not been settled or colonized nor have its various resources been developed, mainly because of its location, morphology, and climate.

The soils found on Sable Island have a deficiency of all common soil fractions with the exception of sand sized mineral particles. Most of the island is made up of a series of dunes and beaches consisting of uniform, clean sand deposits, with little or no organic content. The soils that have developed are found intermittently in sections of existing dunes and around the freshwater ponds found in the central part of the island sheltered by the coastal dunes.

All of the topographical features on the island are temporary and are undergoing relentless and, at times, dramatic changes. The dunes are especially subject to the forces of the wind and are undergoing continuous change in height, profile and location. Both freshwater and salt water ponds are victims of infilling by wind blown sand. The best example of this is Lake Wallace where only a small portion of the old lake is left. The infilled area is the smooth hard, flat south beach used regularly as the landing strip for various types of fixed wing aircraft.

The need for careful planning of construction and development on the island is emphasized by the fragile nature of both the dune systems and the freshwater reservoir. Construction of buildings will alter the natural flow of wind, causing changes in velocity that may adversely affect the landscape at the site. An increase in velocity causes funnelling effects, which result in erosion of sand around the buildings. A decrease in wind velocity would result in the deposition of airborne sand immediately in front of, and in the lee of, buildings. Vehicular movements should also be restricted to areas that are unvegetated and flat. The frequent movement of vehicles over vegetated areas destroys the protective cover and exposes the fine sand grains to the erosive forces of the wind. Tracks made along the steep slopes of dunes form troughs, exposing sand grains to the funnelling effects of the wind which give it a stronger erosion force. The activity leads to the instability of dune slopes which had previously reached a temporary state of equilibrium at the angle of repose.

Of just as much significance in protecting the surface environment of Sable Island is the disposal of both liquid and solid wastes. Disposing of liquid wastes will result in the rapid vertical movement to the water table where flow will continue down the hydraulic gradient. The leachate generated from the disposal of solid wastes will follow the same movement pattern. Disposal sites for such materials should therefore be selected with careful consideration being given to the location of freshwater reservoirs and the groundwater flow systems in the area. Once a solid waste disposal site is established it should be properly maintained. The use of wood lath snow fencing can be very effective in

catching wind blown debris and preventing sand erosion of the disposal site.

The thickness of the freshwater reservoirs, the associated freshwater heads, and the geometry of the various basins present conditions favourable for the development of supplies of good quality groundwater. Such supplies can best be developed through the use of properly located and designed, small diameter, shallow, screened wells. Because of the unconfined nature of the sand aquifer and the proximity of salt water, the safe yield of a well, or well field, will be determined by water quality parameters, rather than by the hydraulics or head losses of the wells. Care must be taken not to locate wells in areas subject to flooding by extreme high tides, or near existing ponds where decaying organic deposits can contribute dissolved gases to the water.

Estimates of the freshwater balance of the island reveal that the mean annual inflow, as total precipitation, is in the order of 20,800 acre-feet (25,369,760 m³). The combined losses of evapotranspiration and groundwater discharge to the sea were estimated to be in the order of 15,900 acre-feet (19,393,230 m³). Therefore, in any given basin on the island the amount of freshwater available for use would be about 25 percent of the total inflow for that area.

REFERENCES

- Austin, G. H., and R. D. Howie, 1971: Regional Geology of Offshore Eastern Canada; in Earth Sciences Symposium on Offshore Eastern Canada, Geol. Surv. Can., Paper 71-23, pp. 73-107.
- Bagnold, R. A., 1941: The Physics of Blown Sand and Desert Dunes; Methuen and Co. Ltd., London, 265 p.
- Berger, J., J. E. Blanchard, M. J. Keen, R. E. McAllister and C. F. Tsong, 1965: Geophysical Observations on Sediments and Basement Structure underlying Sable Island, Nova Scotia; A.A.P.G. Bull., Vol. 49, No. 7, pp. 959-965.
- Bruce, J. P., 1968: Atlas of Rainfall Intensity - Duration Frequency Data for Canada; Dept. of Transport; Met. Br., Toronto, 20 p.
- Cameron, H. L., 1965: The Shifting Sands of Sable Island; The Geographical Review, Vol. 55, No. 4, pp. 463-476.
- Campbell, Lyall, 1974: Sable Island, Fatal and Fertile Crescent; Lancelot Press Ltd., Windsor, N.S., 104 p.
- Environment Canada, 1975: Canadian Tide and Current Tables; Vol. 1 Atlantic Coast and Bay of Fundy, Can. Hydrog. Serv., Ottawa, 83 p.
- Environment Canada, Temperature and Precipitation, 1941-1970; Atlantic Provinces, Toronto, 55 p.
- , 1968: Climatic Normals, Vol. 5, No. 551-552 (71); Toronto.
- , 1972: Hourly Data Summaries, No. 91, Sable Island; Toronto, 26 p.
- Erskine, K. S., 1953: The Ecology of Sable Island, 1952; Proc. N.S. Inst. of Science, Vol. 13, pp. 120-145.
- Evans and Hamilton Inc., 1972: Sable Island Sand Transport, Part II; Kensington, Maryland; prepared for Mobil Oil Canada, Ltd., 46 p.
- Fergusson, Charles Bruce, 1969: The Status of Sable Island; Journal of Education, May-June, pp. 17-18.
- Freeze, R. A., 1967: Potev in Computer Programmes in use by the Hydrologic Sciences Division, Inland Water Branch, Department of E. M. & R.
- Goldthwait, J. W., 1924: Sable Island; In Physiography of Nova Scotia; Geol. Surv. Can. Memoir 140, pp. 141-147.
- Grosvenor, Melville Bell, 1965: Safe Landing on Sable; National Geographic Vol. 128, No. 3, pp. 398-431.
- Hennigar, T. W., 1972: Hydrogeology of the Truro Area, Nova Scotia; Nova Scotia Department of Mines, Report 72-1; 127 p.
- Holmes, Arthur, 1965: Principles of Physical Geology, Ronald Press Co., 1, 288 p.
- King, Lewis H., 1969: Submarine End Moraines and Associated Deposits on the Scotian Shelf; Geol. Surv. Amer. Bull., Vol. 80, pp. 83-96.
- King, L. H. 1970: Surficial Geology of the Halifax-Sable Island map area, Canada; Marine Sciences Branch; Department of E. M. & R.; Paper 1, 15 p.
- Lazreg, H., 1973: Delineation of the fresh water lens in Sable Island Nova Scotia by electrical soundings; unpublished report; Environment Canada; Hydrology Research Division; 17 p.
- MacDonald, Simon D., 1883: Notes on Sable Island; Proc. and Trans. Nova Scotia, Institute National Sciences, Vol. 6, 12-33 pp.
- , 1884: Sable Island; Proc. and Trans, Nova Scotia Institute National Science, Vol. 6, pp. 110-119.
- , 1896: Sable Island, No. 3, Its Probable Origin and Submergence; Proc. and Trans, Nova Scotia Institute National Science, Vol. 6, pp. 265-280.

- MacLaren, B. and L. H. King, 1971:** Surficial Geology of the Banquereau and Misaine Bank Map Area; Marine Sciences Branch; Department of Environment; Geol. Surv. Can. Paper 71-52; 19 p.
- MacLaren, I. A. and C. Bell, 1972:** Birds of Sable Island, Nova Scotia Museum; Halifax, 50 p.
- Magnusson, D. H., 1973:** The Sable Island Deep Test of the Scotian Shelf; Earth Science Symposium on Offshore Eastern Canada, Geol. Surv. Can. Paper 71-23, pp. 253-266.
- Marlowe, J. I., 1967:** The Geology of Part of the Continental Slope Near Sable Island; Geol. Surv. Can. Paper 65-38, 30 p.
- McIver, N. L., 1972:** Cenozoic and Mesozoic Stratigraphy of the Nova Scotia Shelf; Canadian Journal of Earth Sciences, Vol. 9, No. 1, pp. 54-70.
- Mobil Oil Canada Limited, 1971:** Preliminary Hydrological Study, Sable Island; Staff Report, Production Engineering Calgary.
- Munro, W. H., and H. L. Brusset, 1968:** Well History Report for Mobil Sable Island, No. 1, Nova Scotia, Canada; Company report.
- Patterson, Rev. George, 1894:** Sable Island: Its History and Phenomena; Proc. and Trans. Roy. Soc. Canada, Section II, pp. 3-49.
- , 1897: Supplementary Notes on Sable Island; Trans. Roy. Soc. Canada, Section II, pp. 131-137.
- Roland, A. E., and E. C. Smith, 1969:** The flora of Nova Scotia; Nova Scotia Museum; Halifax, 746 p.
- Sable Island Environmental Advisory Committee, 1974:** Sable Island, An Environmental Guide, 18 p.
- Sebert, L. M., 1970:** Every Square Inch, Department of Energy, Mines and Resources, Ottawa, 25 p.
- Snow, Edward Rowe, 1972:** Sable Island; In Ghosts, Gales and Gold; Dodd, Mead and Co., New York, pp. 173-191.
- Stanley, D. J. and A. E. Cok, 1968:** Sediment Transport by ice off the Nova Scotian Shelf; Trans., Nat'l. Symposium on Ocean Sciences and Engineering on Atlantic Shelf, pp. 109-127.
- Stanley, D. J., D. J. P. Swift, N. Silverberg, N. P. James and R. G. Suttin, 1973:** Recent Sand Spill Over of Sable Island Bank, Scotia Shelf; Earth Sciences Symposium on Offshore Eastern Canada, Geol. Surv. Can. Paper 71-23, pp. 167-194.
- Terasmae, J., and R. J. Mott; 1971:** Post Glacial History and Polynology of Sable Island, Nova Scotia; Geo-Science and Man, Vol. 11, pp. 17-28.
- Thornbury, William, D. 1964:** Principles of Geomorphology, John Wiley and Sons, Inc., 618 p.
- Welsh, D. A. 1973:** The Life of Sable Island's Wild Horses; in Nature Canada, Vol. 2, No. 2, pp. 7-14.
- Zimlicki, L. M. and D. A. Welsh, 1975:** Literature Survey for the Terrain Management of Sable Island; CWS; project No. 6122, 85 p.

Appendix A. Groundwater hydrographs from observation well 19 for 1972 to 1974.

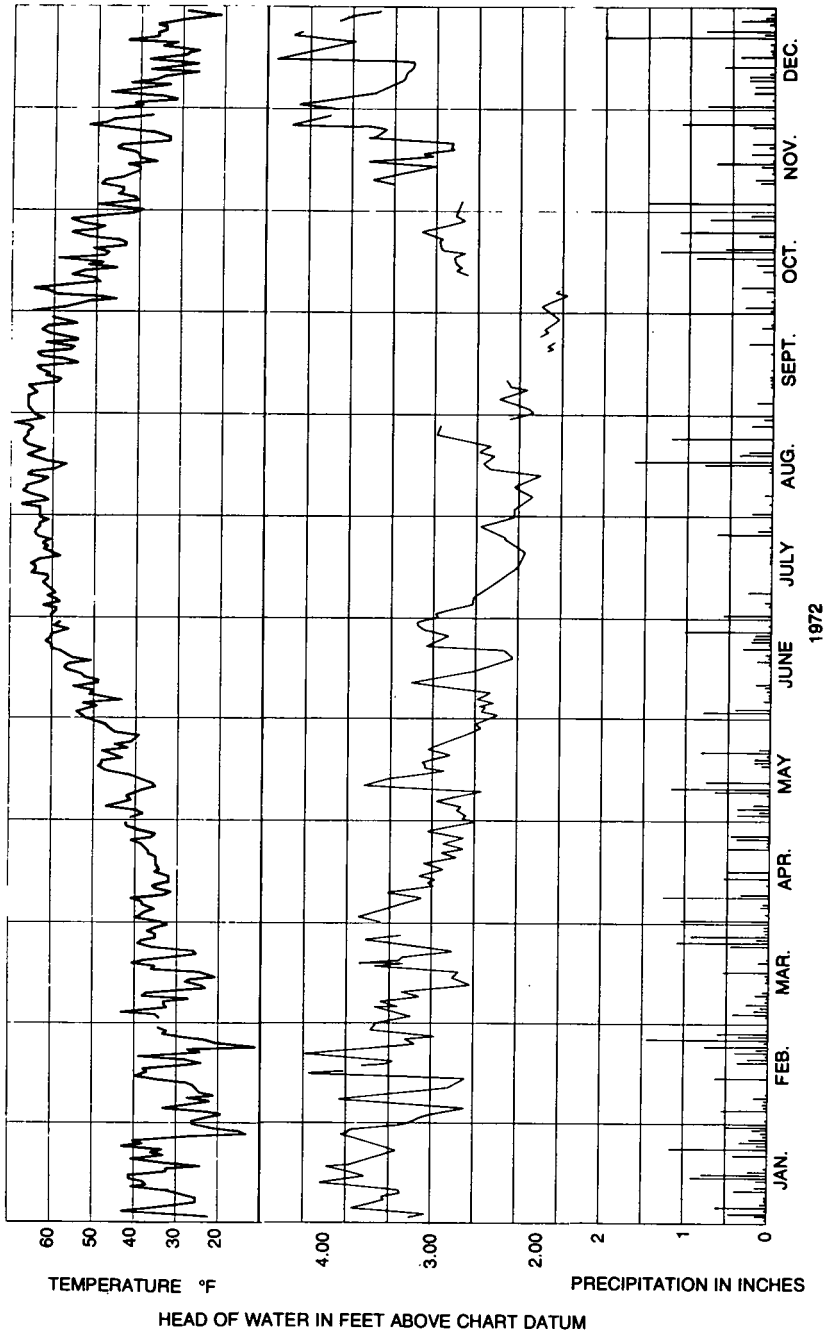

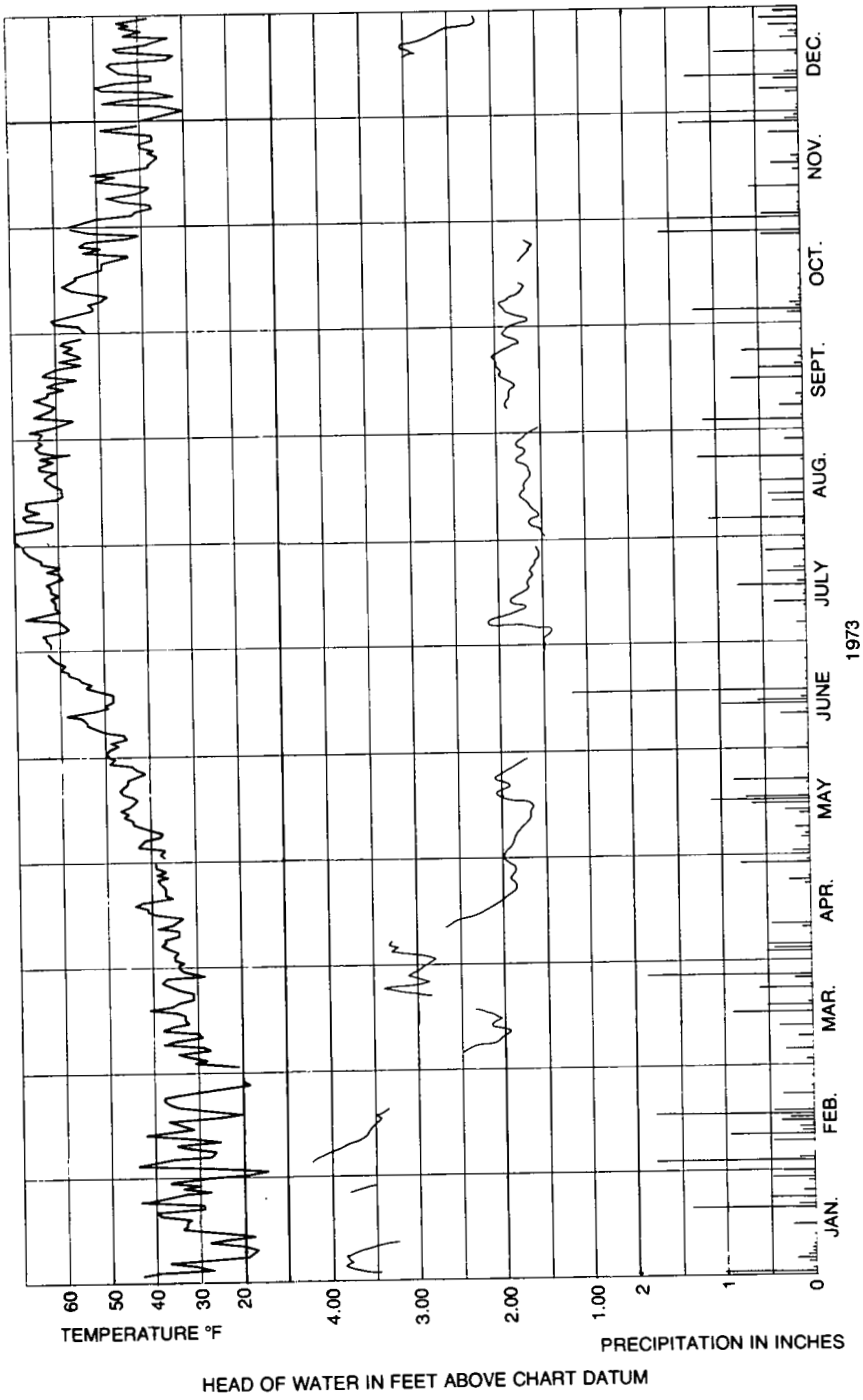

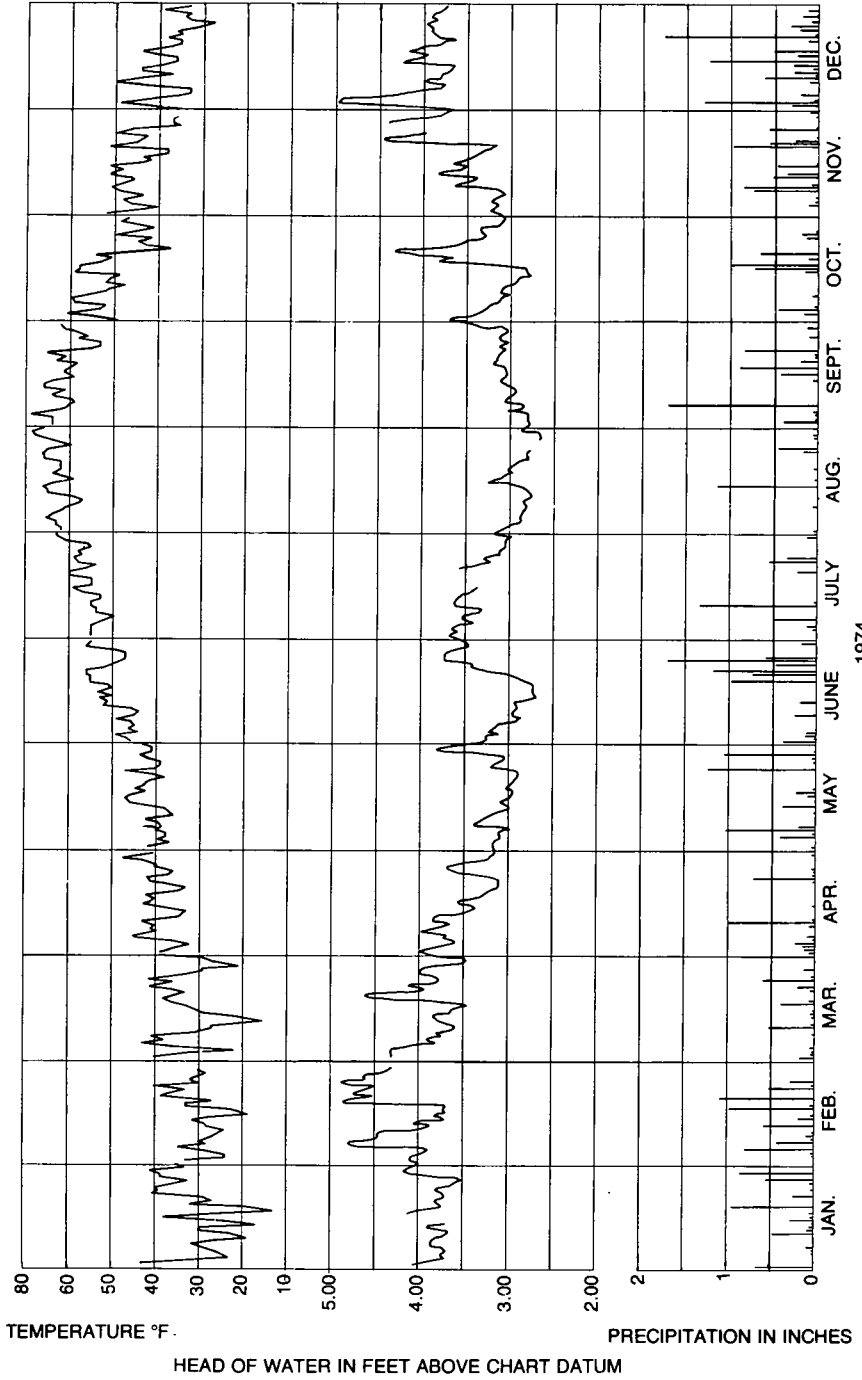

Appendix B. Groundwater hydrograph from observation well 17 for 1972.

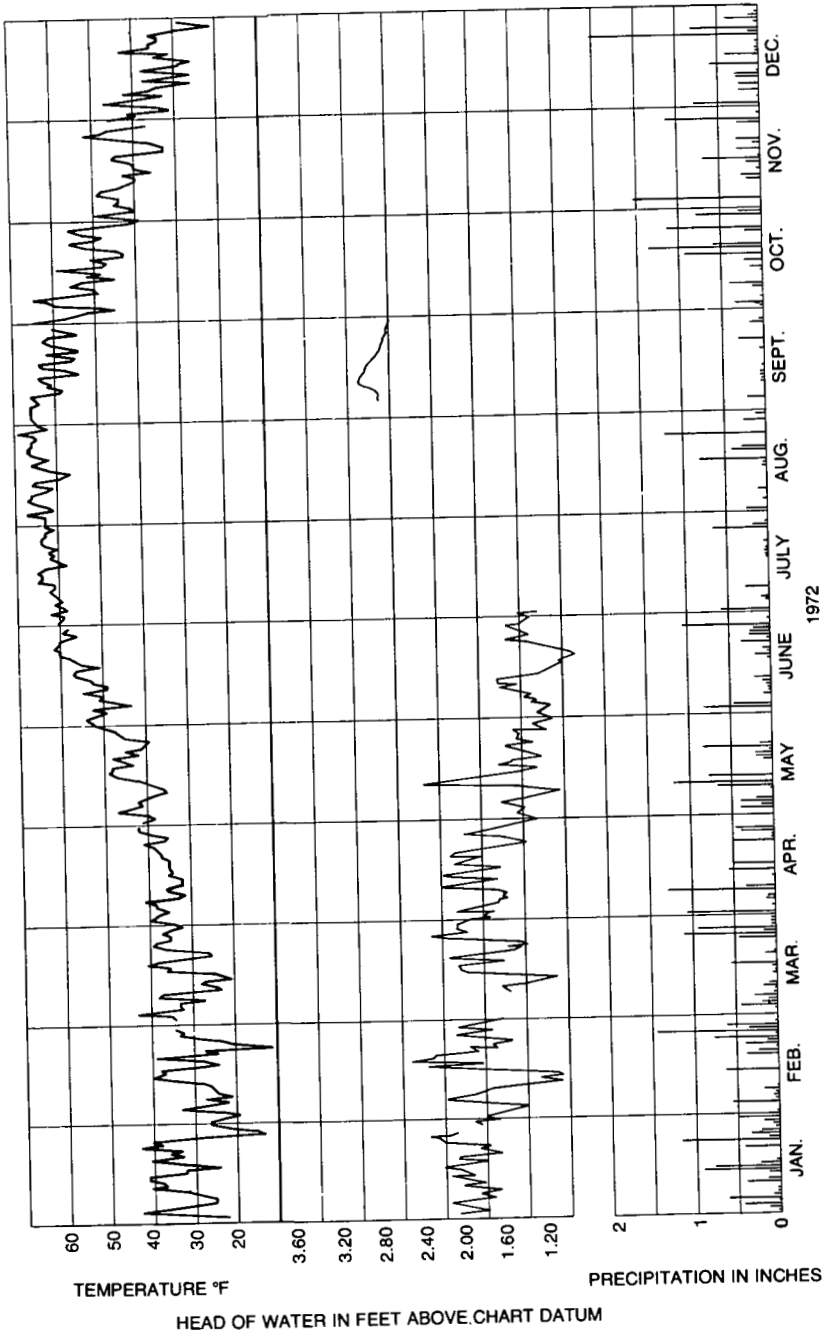

Appendix C. Groundwater hydrographs of observation well 47 for 1973 and 1974.

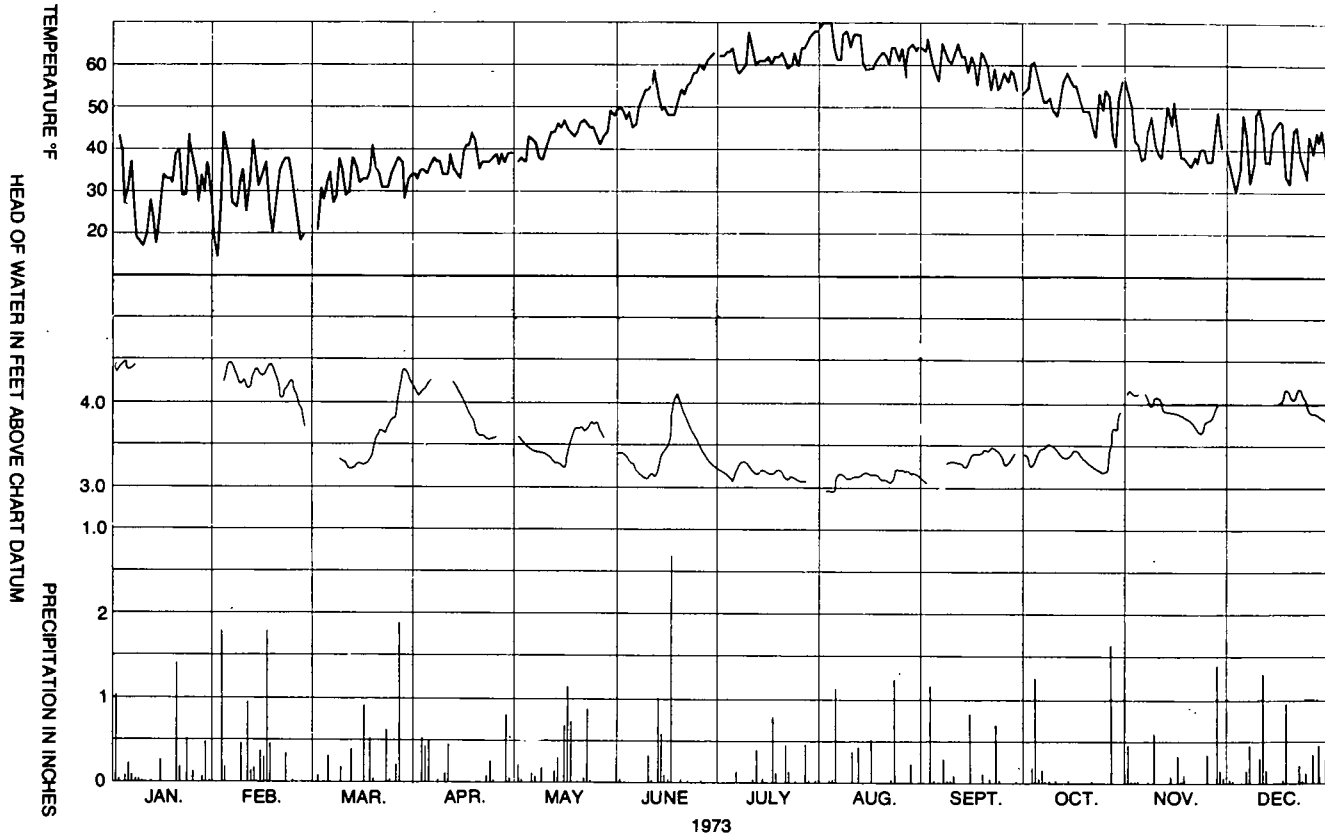

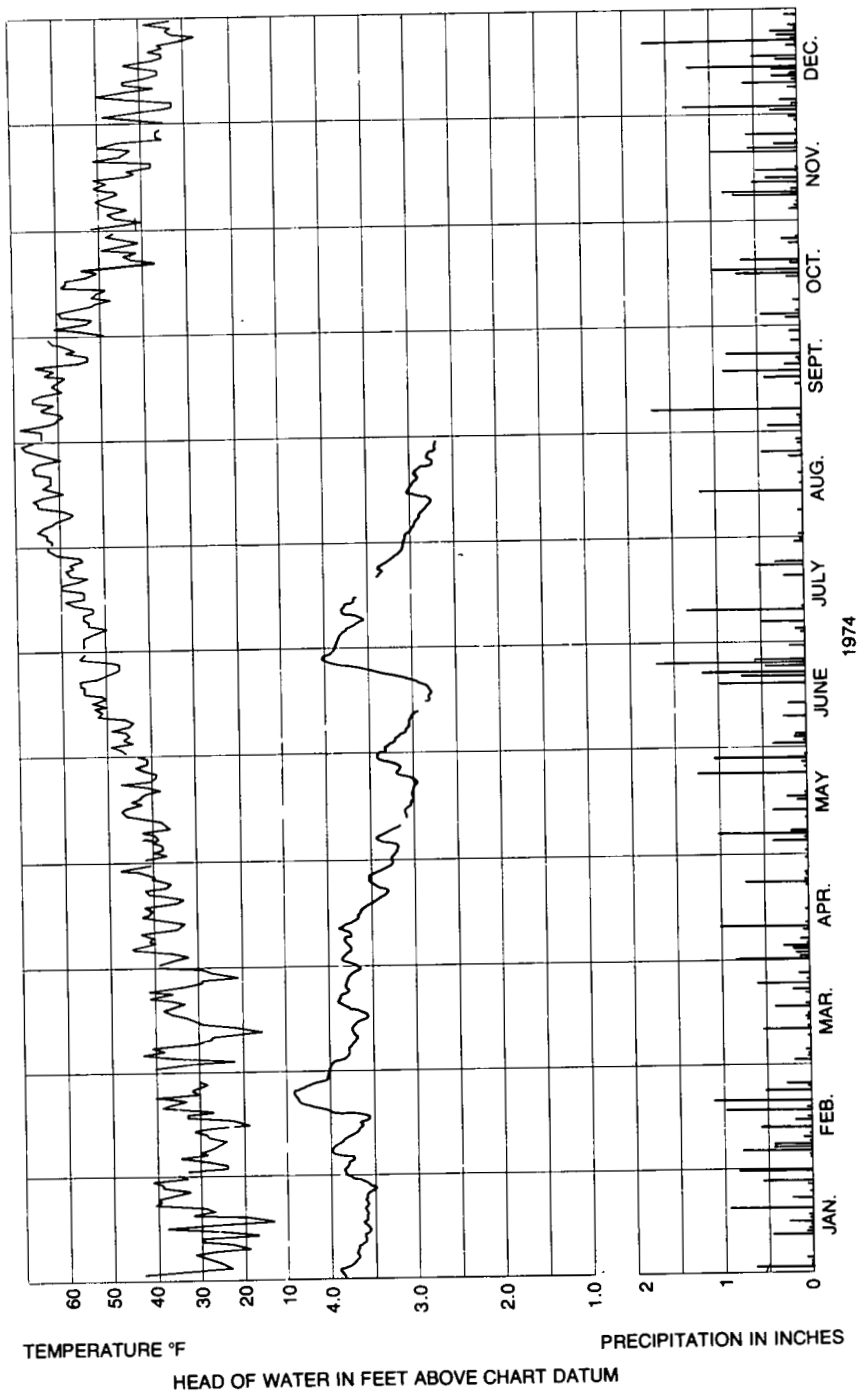

Appendix D. Plot of climatic data recorded at Sable Island station during 1972, 1973, and 1974.

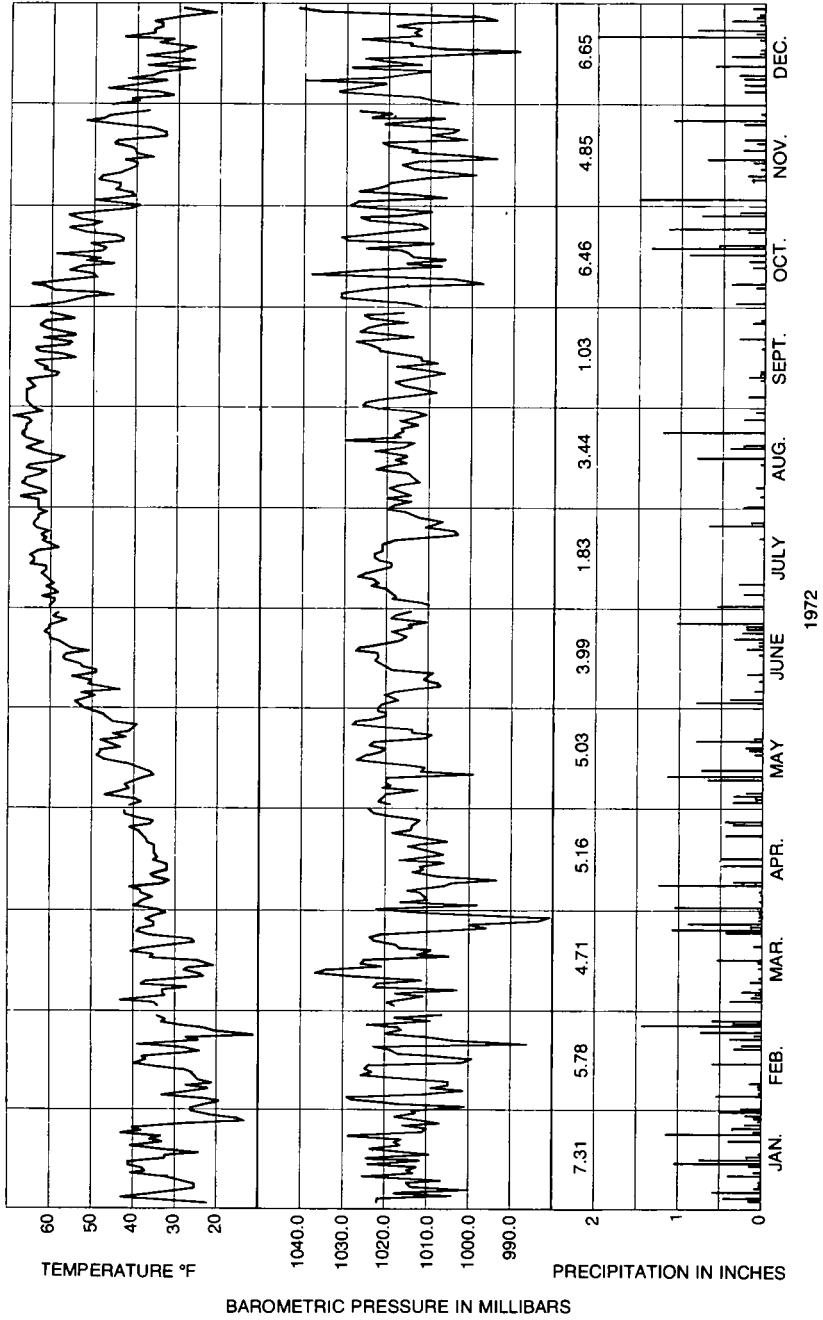

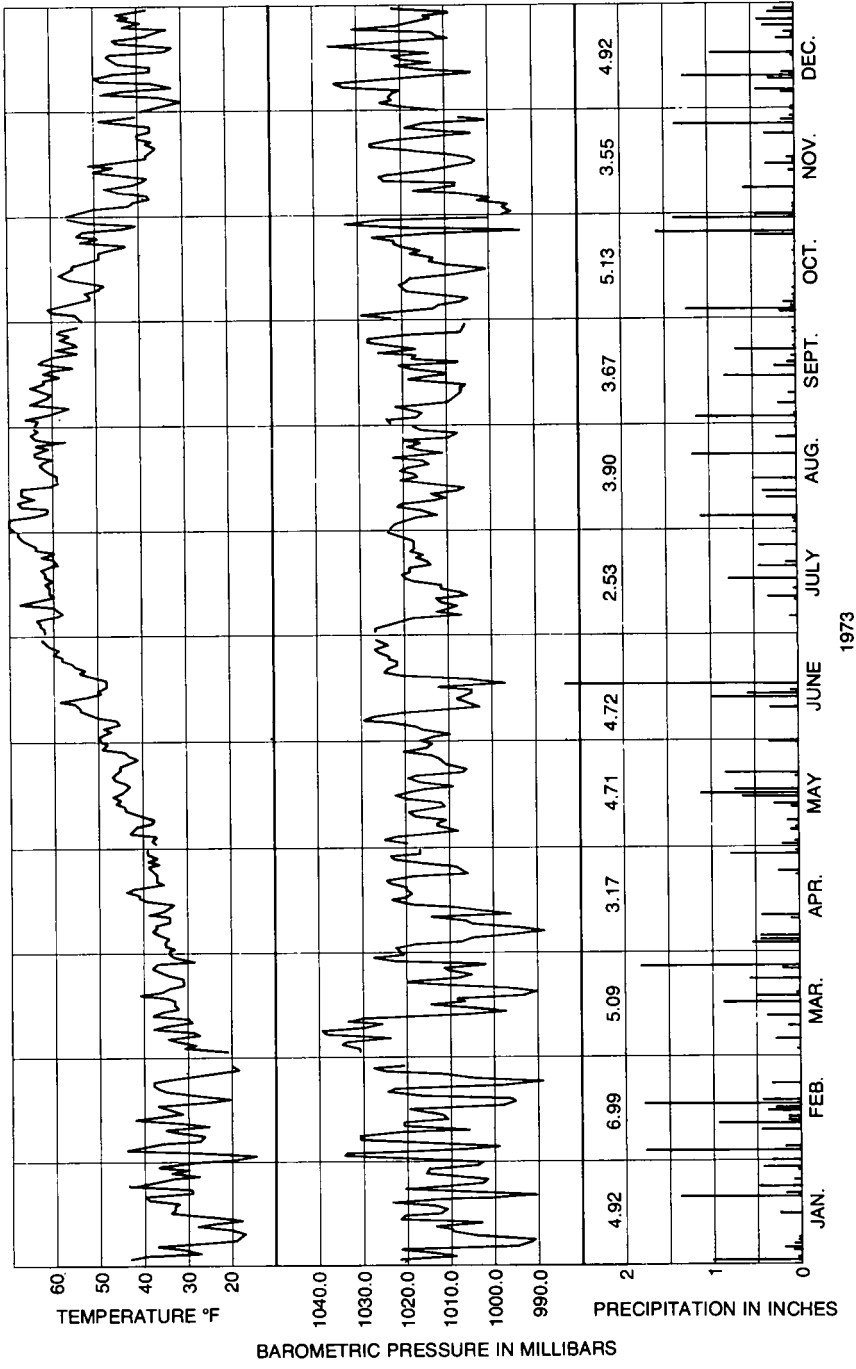

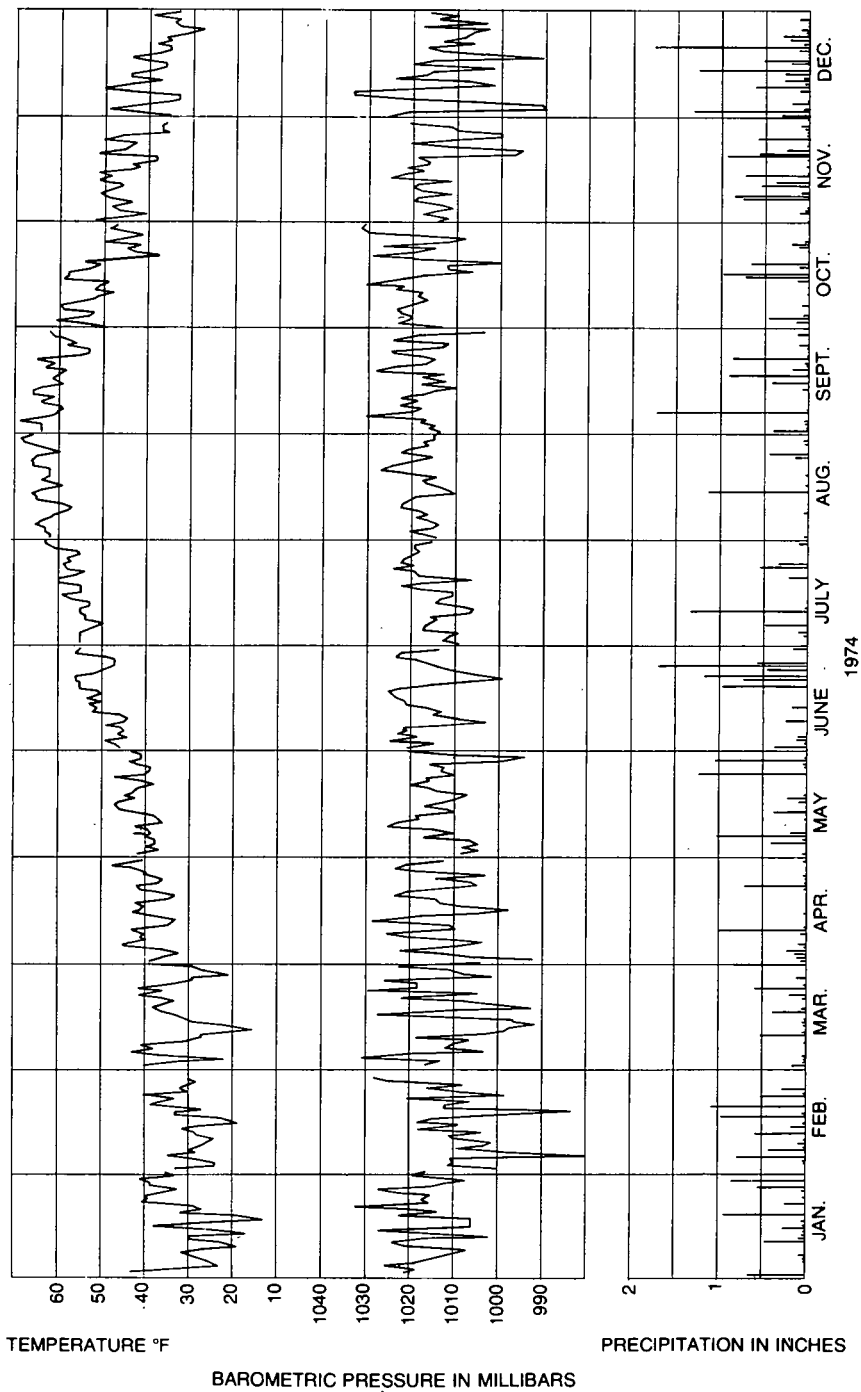

Appendix E. Chemical analyses of water samples collected on Sable Island.

INDEX NO.	GRID LOCATION	AREA	DEPTH (ft)	AQUIFER	DATE SAMPLED	ANALYSES IN PARTS PER MILLION (ppm)																IONS IN EQUIVALENTS PER MILLION (ppm)									
						Ca	Mg	Na	Fe	Mn	SO ₄	Cl	NO ₃	ALKALINITIES			IGNITION LOSS	TOTAL DISSOLVED SOLIDS	SUSPENDED MATTER	SPECIFIC CONDUCTANCE (microhm-cm/25°C)	pH		COLOUR	TURBIDITY	CATIONS			ANIONS			
														PHENOL-PHTHALEIN as CaCO ₃	METHYLO-ORANGE	HARDNESS					FIELD	LAB			FIELD TEMP. °F.	Ca	Mg	Na	SO ₄	Cl	NO ₃
1.1	581686	A.E.S.	14'	Sand	26/5/72	4.8	1.5	21	0.50	0.15	19.5	44	2.2	0	8.2	20	105	120	5.0	5	3.0	0.240	0.123	0.914	0.406	1.241	0.035				
1.2	581686	A.E.S.	14'	Sand	23/11/72	3.6	5.0	20	0.05	0.015	15.5	26.8	2.1	0	15.1	28	135	132	6.4	4	1.0	0.180	0.411	0.870	0.323	0.756	0.034				
1.3	581686	A.E.S.	14'	Sand	24/11/72	4.8	1.45	20	0.12	0.05	14.8	30.8	2.44	0	10.8	24.2	149	137	6.85	5	2.7	0.240	0.119	0.870	0.308	0.869	0.039				
1.4	581686	A.E.S.	14'	Sand	28/4/73	7.2	2.88	24	0.13	0.012	9.8	38	1.5	0	10.7	29	103	135	6.0	1	0.8	0.359	0.237	1.044	0.204	1.072	0.242				
1.5	581686	A.E.S.	14'	Sand	31/8/73	4.7	2.8	21	0.18	0.016	13.2	34	2.9	0	9.0	30	102	140	5.5	4	2.1	0.235	0.230	0.914	0.275	0.959	0.047				
1.6	581686	A.E.S.	14'	Sand	4/10/73	7.2	1.72	23	0.15	0.014	11.34	26	1.77	0	12.6	25.05	95	120	6.0	8	1.5	0.359	0.141	1.001	0.236	0.733	0.029				
1.7	581686	A.E.S.	14'	Sand	22/4/74	4.0	4.3	23	0.34	0.016	20.4	40	2.6	0	6.4	29.6	114	132	5.3	2	1.5	0.240	0.354	1.001	0.425	1.128	0.042				
1.8	581686	A.E.S.	14'	Sand	4/4/74	3.6	2.16	18.5	0.155	0.011	13.17	31.2	2.39	0	6.36	17.9	140	115	5.3	3	1.3	0.180	0.178	0.805	0.274	0.880	0.037				
1.9	581686	A.E.S.	14'	Sand	17/8/74	2.2	4.0	29	0.2	0.06	11.0	52	0.20	0	20		192	200	5.2	3	0.5	0.110	0.329	1.262	0.229	1.467	0.003				
2.1	554689	Mines Comp	13'	Sand	31/8/73	4.8	4.3	42	0.6	0.015	10.9	68	7.1	0	8.0	29	200	260	5.7	12	3.0	0.240	0.354	1.827	0.227	1.918	0.115				
2.2	554689	Mines Comp	13'	Sand	4/10/73	4.8	4.32	39	0.6	0.01	17.8	62	4.43	0	8.4	29.71	190	220	5.5	20	3.0	0.240	0.355	1.697	0.371	1.749	0.071				
2.3	554689	Mines Comp	13'	Sand	18/12/73	2.4	8.64	39.0	0.6	0.014	21.1	62.8	7.8	0	8.52	41.4	175	192	5.6	15	2.3	0.120	0.711	1.697	0.439	1.772	0.129				
2.4	554689	Mines Comp	13'	Sand	22/4/74	4.8	4.32	35	0.48	0.01	15.2	56	5.53	0	6.4	29.7	166	200	5.4	18	1.5	0.240	0.355	1.523	0.316	1.580	0.089				
2.5	554689	Mines Comp	13'	Sand	4/4/74	2.4	5.76	33.0	0.34	0.01	15.27	59.6	5.76	0	8.48	29.6	186	192	5.3	15	1.8	0.120	0.474	1.436	0.318	1.681	0.093				
2.6	554689	Mines Comp	13'	Sand	23/8/74	6.3	15.4	110.0	0.3	0.04	135	220	1.4	0	8.0		502	240	6.1	30	1.3	0.324	1.267	4.785	2.811	6.206	0.023				
2.7	554689	Mines Comp	13'	Sand	9/9/74	3.4	5.5	35.0	0.5	0.03	22	54	1.8	0	5.0		144	276	5.8	30	2.0	0.170	0.452	1.523	0.458	1.523	0.029				
3.1	535691	Mobil Comp	5'	Sand	25/5/72	7.2	5.8	71	0.03	0.005	28.2	120	1.2	0	8.3	42	246	350	5.35	46°F.	1	2	0	0.359	0.477	3.089	0.588	3.385	0.019		
3.2	535691	Mobil Comp	5'	Sand	24/11/72	7.2	5.86	76	0.30	0.11	19.85	116	1.78	0	4.3	43.5	257	395	5.2	2	1.4	0.359	0.482	3.296	0.413	3.272	0.029				
3.3	535691	Mobil Comp	5'	Sand	26/4/73	6.0	7.2	77	0.06	0.009	21.45	120	2.2	0	5.0	45	259	410	4.95	2	0.8	0.299	0.592	3.350	0.447	3.385	0.035				
3.4	535691	Mobil Comp	5'	Sand	4/10/73	5.28	9.79	88	0.38	0.10	25.8	144	5.3	0	8.4	53.3	325		4.8	12	3.0	0.263	0.805	3.828	0.537	4.062	0.085				
3.5	535691	Mobil Comp	5'	Sand	22/4/74	7.2	7.2	80	0.19	0.012	27	140	1.77	0	6.4	47.5	325	410	5.0	2	1.0	0.359	0.592	3.480	0.562	3.949	0.029				
3.6	535691	Mobil Comp	5'	Sand	4/4/74	3.6	3.6	45.0	0.1	0.01	26.01	90.0	4.87	0	21.2	23.8	300	280	5.8			0.180	0.296	1.958	0.542	2.539	0.079				
4.1	569681	T.H.-4	13'	Sand	8/8/71	14.5	20.5	190	0.24	0.01	63	300	0.4	0	31	324	723	3.0	7.15	60	1.5	0.724	1.684	8.265	1.312	8.463	0.006				
4.2	569681	T.H.-4	13'	Sand	26/5/72	9.5	8.5	48	2.8	0.45	30	155	0.9	0	30	65	359		7.6			0.474	0.699	2.088	0.625	4.373	0.015				
4.3	569681	T.H.-4	13'	Sand	27/8/72	12.6	32.4	320	1.68	0.015	75	575	1.33	0	29.5	166	1142	1450	6.33	54°F.	>70	3	0.429	2.665	13.920	1.562	16.158	0.021			
4.4	569681	T.H.-4	13'	Sand	29/8/72	19.2	49.7	625	0.8	0.019	124	845	2.08	0	43.3	266	1920	2550	7.03	>70	2.1	0.958	4.082	27.188	2.582	23.837	0.034				

CHEMICAL ANALYSIS OF GROUNDWATER FROM SABLE ISLAND, NOVA SCOTIA

INDEX NO.	GRID LOCATION	AREA	DEPTH (ft)	AQUIFER	DATE SAMPLED	ANALYSES IN PARTS PER MILLION (ppm)																	IONS IN EQUIVALENTS PER MILLION (epm)									
						Ca	Mg	Na	Fe	Mn	SO ₄	Cl	NO ₃	ALKALINITIES			HARDNESS	IGNITION LOSS	TOTAL DIS-SOLVED SOLIDS	SUSPENDED MATTER	SPECIFIC CONDUCTANCE (microhm. #10-9)	pH		FIELD TEMP. °F	COLOUR	TURBIDITY	CATIONS			ANIONS		
														PHENOL - mg/l. or less	ALUMINUM - mg/l. or less	COPPER - mg/l. or less						FIELD	LAB				Ca	Mg	Na	SO ₄	Cl	NO ₃
11.1		T. H.-11	15'	Sand	28/8/72	40.8	78.5	825		1.0	254	1390	3.1	0			2656	3650	6.48				2.036	6.457	35.888	5.265	38.930	0.050				
12.1		Rabbit Drilling Supply	5'	Sand	25/5/72	31.2	72	630	0.17	0.015	165	1100	4.4	0	29	380	2880	3000	7.10		10	3.8	1.557	5.922	27.405	3.435	31.031	0.071				
13.1	575686	West Light	15'	Sand	22/8/71	7.2	2.5	25	0.05	0.05	12.8	43	2.5	0	18	23	13.9	121	5.9	180	6.4	12	2.5	0.359	0.206	1.088	0.266	1.213	0.040			
13.2	575686	West Light	15'	Sand	23/11/72	3.6	3.6	29	0.14	0.02	13.6	40.5	3.23	0	4.3	24.2	162	150	5.36	20	1.5	0.180	0.296	1.262	0.283	1.143	0.052					
13.3	575686	West Light	15'	Sand	28/4/73	6.0	3.6	36	0.11	0.025	10.76	60	2.6	0	4.3	29	154	215	4.9	20	0.5	0.299	0.296	1.566	0.224	1.693	0.042					
13.4	575686	West Light	15'	Sand	31/8/73	3.6	3.6	37	0.31	0.06	10.9	52	1.6	0	9.0	23.4	163	200	5.7	15	3.7	0.180	0.296	1.610	0.227	1.467	0.026					
13.5	575686	West Light	15'	Sand	4/10/73	3.6	4.32	30	5.4	0.11	10.8	46	2.2	0	8.4	26.71	152	180	5.0	190	25	0.180	0.355	1.306	0.225	1.298	0.035					
15.1	588687	DOT Garage		Sand	23/8/71	26.5	4.3	31	0.85	0.03	32	54	3.7	11	110	85	65.7	288	370	8.9	>70	12	1	322	0.354	1.349	0.666	1.517	0.060			
16.1	581688	NW of DOT Garage	50'	Sand	27/8/71	20		200									750	7.0														
17.1	581687	TH-17	100'	Sand	8/10/71	132	336	3100	13	0.22	480	5200	0.4	0	173	1790	1750	11245	12000	7.0				6.589	27.639	134.9	14.156	146.7	0.006			
18.1	580684	TH-18	100'	Sand	31/8/71	92	225	1850	13	0.2	400	3160	1.3	11	95	1050	6799	8500	8.4				4.591	18.509	80.475	8.328	89.144	0.021				
18.2	580684	TH-18	100'	Sand	1/9/71	95	230	1850	0.55	0.25	405	3180	2.0	0	85	1060	6695	8500	7.5				4.741	18.920	80.475	8.432	89.708	0.032				
18.3	580684	TH-18	100'	Sand	7/10/71	85	220	1850	0.42	0.20	365	3100	0.50	0	86	1100	500	6976	7800	7.3				4.242	18.097	80.475	7.599	87.451	0.008			
19.1	579681	TH-19	100'	Sand	19/9/71	7.2	7.3	71.5	12.8	0.23	25	110	0.6	0	22	45	44.8	285	70	400	6.95	>70	40	3.359	0.600	3.110	0.521	3.103	0.010			
19.2	579681	TH-19	100'	Sand	20/10/71	193	505	4100	0.05	0.05	1050	7200	0.6	0	130	2650	1938	15457	18000	7.85				9.631	41.541	178.350	21.861	203.1	0.010			
21.1	709689	TH-21	57'	Sand	12/10/71	7.5	2.9	37.5	12.5	0.55	23	48	2.0	0	38	38	31	176	230					0.374	0.239	1.631	0.479	1.354	0.032			
21.2	709689	TH-21	57'	Sand	23/5/72	8.5	3.6	4.3		0.55	25.3	60	2.8	0	25	36	181	260	7.2				0.424	0.296	0.187	0.527	1.693	0.045				
22.1	709688	TH-22	198'	Sand	18/9/71	9.4	3.0	48.5	13.1	0.34	20.5	78	3.5	0	18	32	185	285	7.5	>70	45		0.469	0.247	2.110	0.427	2.200	0.056				
23.1	710687	TH-23	195'	Sand	18/9/71	7.5	4.5	40	10.9	0.45	23	80	3.2	0	12	38	187	290	4.8	70			0.374	0.370	1.740	0.479	2.257	0.052				
23.2	710687	TH-23	195'	Sand	12/10/71	144	250	2350	0.10	0.90	655	4000	0.9	0	97	1370	932	8588	10000	7.25	62°F.			7.186	20.565	99.875	13.637	112.8	0.015			
24.1	711683	TH-24	55'	Sand	5/8/72	4.0	1.7	21	0.66	0.043	12.7	32	1.32	0	6.2	16	83	112	5.20		20	10	0.200	0.140	0.914	0.264	0.903	0.215				
26.1	580682	TH-26	25'	Sand	1/9/71	6.0	4.4	31	2.8	0.3	15	44	2.3	0	14	25	155	180	6.9	50	65	0.299	0.362	1.349	0.312	1.241	0.037					
26.2	580682	TH-26	25'	Sand	5/8/72	3.6	1.7	21	0.62	0.025	10	33	0.44	0	4.2	14	85	120	4.9	12	8.0	0.180	0.140	0.914	0.208	0.931	0.007					
26.3	580682	TH-26	25'	Sand	1/10/72	2.4	3.6	25	13.5	0.4	15.4	40.4	1.02	0	12.9	28	134	132	5.02	>70	41	0.120	0.296	1.088	0.321	1.140	0.016					
27.1	580685	TH-27	200'	Sand	7/10/71	370	1070	9500	11.6	0.55	2350	16500	0.5	3.8	159	5750	6300	36400	65	34000	8.25	>70	40	18.403	88.018	413.250	48.927	465.5	0.008			
28.1	712682	TH-28	179'	Sand	25/5/72	6.0	3.5	48	12.5	0.60	16.5	78	0	0	20.5	30	174	270	7.4				0.299	0.288	2.088	0.344	2.200	0				

CHEMICAL ANALYSIS OF GROUNDWATER FROM SABLE ISLAND, NOVA SCOTIA

INDEX NO.	GRID LOCATION	AREA	DEPTH (ft)	AQUIFER	DATE SAMPLED	ANALYSES IN PARTS PER MILLION (ppm)																	IONS IN EQUIVALENTS PER MILLION (ppm)								
						Ca	Mg	Na	Fe	Mn	SO ₄	Cl	NO ₃	ALKALINITIES		HARDNESS	IGNITION LOSS	TOTAL DIS-SOLVED SOLIDS	SUSPENDED MATTER	SPECIFIC CONDUCTANCE (microhm. x 10 ⁻⁵)	pH		FIELD TEMP. °F	COLOUR	TURBIDITY	CATIONS			ANIONS		
														PHENOL-PHTHALEIN or CaCO ₃	METHYL ORANGE						FIELD	LAB				Ca	Mg	Na	SO ₄	Cl	NO ₃
29.1	710685	T. H. -29	105'	Sand	18/9/71	5.3	7.3	46	11.5	0.23	21	80	5.6	0	12	37	215	32	290	6.5		>70	25	0.264	0.600	2.001	0.437	2.237	0.090		
29.2	710685	T. H. -29	105'	Sand	1/8/72	7.2	3.6	46	0.19	0.017	10	71	2.65	0	8.0	32	200			5.5	50°F.	70	2.0	0.359	0.296	2.001	0.208	2.00	0.043		
30.1	709687	T. H. -30	55'	Sand	18/9/71	7.5	3.0	50	13.5	0.5	28	82	3.0	0	11	32	26	210	310	5.5		>70	65	0.374	0.247	2.175	0.583	2.313	0.484		
30.2	709687	T. H. -30	55'	Sand	9/10/71	17	10.2	59.5	8.8	0.52	24	82	4.6	0	70	84	272		380	7.8				0.848	0.839	2.588	0.500	2.313	0.074		
30.3	709687	T. H. -30	55'	Sand	25/5/72	16.0	7.2	55	12.4	0.65	28	88	1.55	0	58	70	270		350	7.4				0.798	0.592	2.393	0.583	2.482	0.025		
32.1	719689	T. H. -32	100'	Sand	19/9/71	9.6	2.0	70.5	11.7	0.38	26	100	2.0	0	35	35	194		365	7.35		15	35	0.479	0.165	3.067	0.541	2.821	0.032		
32.2	719689	T. H. -32	100'	Sand	2/10/71	< 20		230											800	8.3											
33.1	799759	T. H. -33	26'	Sand	2/10/71	< 20		385											1750	7.8											
34.1	798760	T. H. -34	50'	Sand	2/10/71	27	19	320	0.26	1.1	120	460	1.5	0	65	138	30	1040	1500	6.9				1.347	1.563	13.92	2.498	12.977	0.024		
34.2	798760	T. H. -34	50'	Sand	27/4/73	19.3	62	620	1.8	0.06	140	970	0.55	0	21.5	308		1950	290	6.0		30	40	0.963	5.100	26.97	2.915	27.364	0.009		
35.1	608685	T. H. -35	50'	Sand	18/9/71	7.2	2.9	31	0.25	0.20	28	50	1.8	0	12	35	155		180	6.2				0.359	0.239	1.349	0.583	1.411	0.029		
35.2	608685	T. H. -35	50'	Sand	19/10/71	4.8	90	900	0.12	0.60	225	1470	4.0	0	66	510	414	3180	4300	7.75				0.240	7.403	39.150	4.685	41.469	0.065		
35.3	608685	T. H. -35	50'	Sand	25/5/72	300	795	7000	0.78	1.3	1650	11800	1.33	0	74	4030		25407	20000	7.8		20	8.0	14.970	65.397	304.500	34.353	332.88	0.021		
37.1	568687	T. H. -37	17'	Sand	2/10/71	8.4	4.5	24	0.3	0.02	12	40	3.0	0	25	36	149		180	6.3				0.419	0.370	1.044	0.250	1.128	0.048		
39.1	568687	T. H. -39	15'	Sand	1/8/72	36.5	3.6	46.5	0.25	0.025	12	73	2.21	0	14.5	36.5	207		210	6.1		70	2.0	1.821	0.296	2.023	0.250	2.059	0.036		
40.1	580682	T. H. -40	25'	Sand	5/8/72	2.9	2.1	22.5	1.7	0.04	15	36	0.88	0	2.06	14	95.8		145	4.5		70	10	0.145	0.173	0.979	0.312	1.016	0.014		
41.1	708687	T. H. -41	14'	Sand	31/8/72	4.8	2.18	30.5	0.43	0.01	6.5	46	1.41	0	5.2	22	136		170	5.45		2	1.5	0.240	0.179	1.327	0.135	1.298	0.023		
41.2	708687	T. H. -41	14'	Sand	10/9/72	3.8	2.2	31	0.15	0.01	10.6	44	1.1	0	5.9	20	115		160	5.3		25	20	0.190	0.181	1.349	0.221	1.241	0.018		
41.3	708687	T. H. -41	14'	Sand	11/9/72	3.6	1.4	32	0.23	0.01	11	43	2.0	0	5.2	16	117		160	5.35	54°F.	40	2.5	0.180	0.115	1.392	0.229	1.213	0.032		
41.4	708687	T. H. -41	14'	Sand	18/9/72	6.0	1.1	17	0.2	0.01	9.8	38	2.40	0	10	20	104		150	5.25		1.8	45	0.299	0.090	0.740	0.204	1.072	0.039		

CHEMICAL ANALYSIS OF SURFACE WATER FROM SABLE ISLAND, NOVA SCOTIA
ANALYSES IN PARTS PER MILLION (ppm)

INDEX NO.	GRID LOCATION	AREA	DEPTH (ft)	AQUICL	DATE SAMPLED	Ce	Mg	Na	Fe	Mn	SO ₄	Cl	NO ₃	ALCALINITIES			HARDNESS	IGNITION LOSS	TOTAL DISSOLVED SOLIDS	SUSPENDED MATTER	SPECIFIC CONDUCTANCE (microhm-cm x 10 ⁻³)	P.H.		FIELD TEMP. °F	COLOUR	TURBIDITY	IONS IN EQUIVALENTS PER MILLION (ppm)					
														PHENOL-PTHALEIN	CaCO ₃	METHEMOXY						Ca	Mg				Na	SO ₄	Cl	NO ₃		
5.1	687 687	Pond Near Old #3			24/5/72	200	780	6250	0.20	0.045	1432	9600	0	18	95	3400	19977	19977	20000	8.35	5.0	1.6	11.477	64.163	271.875	29.814	270.8	0				
6.1	686 680	Pond			21/8/72	370	1100	9600	0.35	0.10	2240	18500	0.4	0	120	5500	4500	30000	8.2	3.0	20	18.444	90.484	417.600	46.637	465.5	0.004					
8.1	687 685	Lake NW of Old #3			24/8/74	3.9	5.6	37	3.3	0.08	6.0	11	<0.1	61	32	212	250	250	6.4	2.5	35	0.195	0.461	1.610	0.125	0.310	0.002					
9.1	685 680	Lake on South Beach			17/8/74	138	401	2000	0.2	0.2	820	5500	<0.1	52	1995	12670	17000	17000	8.1	1.0	15	6.886	32.966	87.000	17.072	155.2	0.002					
10.1	688 684	Pond			26/8/71	7.3	7.2	57	0.61	0.08	20	82	1.5	0	15	42	219	325	6.8	3.5	12	0.344	0.592	2.480	0.416	2.313	0.024					
36.1	730 689	New Water Hole			2/10/71	2.5	1.5	15.5	0.43	0.02	11	20	2.8	0	12	12	78.5	69	5.4	3.0	70	-0.125	0.123	0.674	0.229	0.364	0.045					
42.1	695 679	Salt Lake (LN-1)			4/9/71	340	940	8800	0.22	0.06	2100	14500	1.4	13	95	4900	34370	28000	8.25	3.8	70	16.946	78.970	382.800	43.722	409.0	0.023					
43.1	672 682	Fresh Lake (LN-2)			4/9/71	5.5	5.8	40	0.23	0.02	15	66	1.7	0	12	33	170	250	5.5	2.0	7	0.275	0.477	1.740	0.312	1.862	0.274					
43.2	672 682	Fresh Lake (LN-2)			22/8/74	3.2	4.5	35	0.1	0.04	16.0	62	0.9	1.0	1.0	218	218	250	4.4	0.4	10	0.160	0.370	1.323	0.331	1.749	0.015					
44.1	719 690	Pond (LN-3)			10/9/71	9.6	5.8	51	0.10	0.25	44.5	96	75	0	12	45	421	500	4.8	4.8	35	0.479	0.477	2.219	0.927	2.708	1.210					
45.1	689 685	Lake (LN-4)			12/9/71	180	475	4600	0.18	0.02	850	7800	1.7	20	105	2450	14075	18000	9.18	4.5	35	8.982	39.074	200.100	17.697	220.0	0.027					
46.1	608 684	Lake Wellace (LN-5)			12/9/71	300	880	7900	0.3	0.05	2050	13300	1.3	13	110	4640	27474	27000	8.8	10	15	14.970	72.389	326.250	42.681	372.4	0.021					