

# **SD 23**

## **Geotechnical Investigation – Waste Rock Storage Area Drainage Ditches – Phase 3**





**Geotechnical Investigation -  
Waste Rock Storage Area  
Drainage Ditches – Phase 3**

Touquoy Gold Project, Middle  
Musquodoboit, Nova Scotia

February 23, 2021

Prepared for:

Atlantic Mining NS Inc.  
6749 Moose River Road, RR#2  
Middle Musquodoboit, NS  
B0N 1X0

Prepared by:

Stantec Consulting Ltd.  
845 Prospect Street  
Fredericton, NB E3B 2T7



### GEOTECHNICAL INVESTIGATION - WASTE ROCK STORAGE AREA DRAINAGE DITCHES – PHASE 3

This document entitled Geotechnical Investigation - Waste Rock Storage Area Drainage Ditches – Phase 3 was prepared by Stantec Consulting Ltd. (“Stantec”) for the account of Atlantic Mining NS Inc. (the “Client”). Any reliance on this document by any third party is strictly prohibited. The material in it reflects Stantec’s professional judgment in light of the scope, schedule and other limitations stated in the document and in the contract between Stantec and the Client. The opinions in the document are based on conditions and information existing at the time the document was published and do not take into account any subsequent changes. In preparing the document, Stantec did not verify information supplied to it by others. Any use which a third party makes of this document is the responsibility of such third party. Such third party agrees that Stantec shall not be responsible for costs or damages of any kind, if any, suffered by it or any other third party as a result of decisions made or actions taken based on this document.

Prepared by   
\_\_\_\_\_  
(signature)

**Mark Palmer, P.Eng.**

Reviewed by   
\_\_\_\_\_  
(signature)

**Jeff Gilchrist, P.Eng.**

Approved by   
\_\_\_\_\_  
(signature)

**Paul Deering, P.Eng., P.Geo.**



**GEOTECHNICAL INVESTIGATION - WASTE ROCK STORAGE AREA DRAINAGE DITCHES –  
PHASE 3**

**Table of Contents**

**1.0 INTRODUCTION.....2.1**

**2.0 SUBSURFACE INVESTIGATION .....2.1**

2.1 GEOTECHNICAL INVESTIGATION PROGRAM.....2.1

2.2 SITE SURVEY.....2.2

2.3 LABORATORY TESTING.....2.2

**3.0 SUMMARIZED SUBSURFACE CONDITIONS .....3.3**

3.1 SOIL AND BEDROCK .....3.3

3.2 GROUNDWATER CONDITIONS .....3.5

**4.0 DISCUSSION AND RECOMMENDATIONS.....4.1**

4.1 GENERAL .....4.1

4.2 SUMMARY OF SUBSURFACE CONDITIONS AND CONSTRUCTION WORK .....4.1

4.3 RECOMMENDATIONS .....4.3

4.3.1 Erosion and Sediment Control.....4.3

4.3.2 Temporary Excavations Slopes .....4.3

4.3.3 Bedrock / Till Excavation .....4.4

4.3.4 Construction Dewatering .....4.4

4.3.5 Field Inspection .....4.4

4.3.6 Winter Construction.....4.4

**5.0 CLOSING.....5.1**

**LIST OF TABLES**

Table 3.1 Test Pit Coordinates and Elevations.....2.2

Table 3.1 Subsurface Conditions Summary .....3.3

**LIST OF APPENDICES**

**APPENDIX A STATEMENT OF GENERAL CONDITIONS.....B.1**

A.1 Statement of General Conditions.....B.1

**APPENDIX B DRAWINGS .....B.2**

B.1 Drawing SK-86: Waste Rock Storage Area Phase 3 Ditch Design.....B.2

**APPENDIX C TEST PIT RECORDS.....C.3**

C.1 Symbols and Terms Used on Borehole and Test Pit Records .....C.3

C.2 Test Pit Records: TP1A To TP7a.....C.3

**APPENDIX D LABORATORY TESTING .....D.4**

D.1 Gradation Curves .....D.4

D.2 Atterberg Limits .....D.4



**GEOTECHNICAL INVESTIGATION - WASTE ROCK STORAGE AREA DRAINAGE DITCHES –  
PHASE 3**



# GEOTECHNICAL INVESTIGATION - WASTE ROCK STORAGE AREA DRAINAGE DITCHES – PHASE 3

Introduction

## 1.0 INTRODUCTION

At the request of Atlantic Mining NS Inc. (AMNS), Stantec Consulting Ltd. (Stantec) completed a geotechnical investigation to support design of the Waste Rock Storage Area (WRSA) expansion drainage ditch construction at the Touquoy Gold Project in Middle Musquodoboit, Nova Scotia.

In accordance with the details provided in our proposal dated October 16, 2020, it is understood that AMNS plans to expand the previously defined WRSA footprint to the north/northwest as detailed on the design drawings for Phase 3 of the WRSA drainage plan (refer to attached Drawing No SK-86; Rev. 2). Details of the proposed drainage plan were provided in Stantec's memorandum *Doc. No. MEM-147-900.300-C-23DEC20. "Waste Rock Storage Area Drainage Ditches – Phase 3, Touquoy Gold Mine, Moose River, NS", dated December 23, 2020.*

The purpose of the drainage ditches and ponds associated with the WRSA expansion is to collect and convey surface water runoff and shallow seepage from the WRSA stockpile during active mine operation. In general, we understand that the expansion construction will consist of the following:

- grubbing for Phase 3 expansion of WRSA;
- construction of approximately 850m of perimeter ditch including approximately 350 m of exterior berm; and
- installation of 205m long culvert.

The proposed scope of work consisted of excavating seven (7) test pits along the alignment of the proposed WRSA Drainage Ditch. However, two additional test pits were completed based on discussions with AMNS prior to the field work being completed.

## 2.0 SUBSURFACE INVESTIGATION

### 2.1 GEOTECHNICAL INVESTIGATION PROGRAM

The geotechnical field investigation, consisting of excavating nine (9) test pits (identified as TP1A, TP1B, TP2A, TP2B, TP3A to TP7A), was completed between January 7<sup>th</sup>, 2021 and January 25<sup>th</sup>, 2021. The test pits were completed along the proposed drainage ditch of the WRSA. The locations of the test pits are shown on Drawing No. SK-86; Rev. 2, located in Appendix B.

The test pitting program was completed using a track-mounted John Deere 210G excavator, owned and operated by NR Kenney Logging Ltd. from Westville, NS. Test pits were excavated to depths between 1.4 metres (m) to 6.0 m below existing ground surface.



# GEOTECHNICAL INVESTIGATION - WASTE ROCK STORAGE AREA DRAINAGE DITCHES – PHASE 3

## Subsurface Investigation

Stantec geotechnical personnel from our Dartmouth, NS office monitored the test pit program, collected soil samples, and logged the subsurface conditions encountered at each test pit locations. Grab samples of overburden soils were obtained during test pit excavation. Descriptions of the soils encountered are provided in Section 3 and on the Test Pit Records located in Appendix C.

Disturbed grab soil samples were stored in moisture tight bags and returned to our laboratory for further classification and testing. If requested, the samples may be kept in storage for a period of three months from the date of issuance of this report, otherwise the samples will be discarded.

Upon completion of the test pit program, the test pits were backfilled with the spoils with the excavation equipment lightly compacting the soils back to the original grade.

## 2.2 SITE SURVEY

The test pit locations were laid out in the field by Stantec and AMNS personnel based on the proposed drainage ditch alignment, and in relation to the existing site features, surface constraints, permit requirements and above or underground utilities.

The coordinates of the as-excavated test pit locations were provided by AMNS and are summarized in Table 3.1 for ready reference. The test pit locations are shown on the attached Drawing No. SK-86; Rev. 2, located in Appendix B.

**Table 3.1 Test Pit Coordinates and Elevations**

Test Pit ID	Northing (m)	Easting (m)	Elevation (m)
TP1A	4981904.5	505514.6	125.8
TP1B	4982053.9	505506.0	125.2
TP2A	4981940.3	505516.7	124.6
TP2B	4982122.1	505967.9	131.1
TP3A	4982107.1	505534.0	125.2
TP4A	4982134.5	505615.8	127.3
TP5A	4982134.3	505674.6	133.2
TP6A	4982136.9	505761.2	132.6
TP7A	4982135.2	505830.1	131.2

\*Note: Coordinate information provided by AMNS

## 2.3 LABORATORY TESTING

The geotechnical laboratory testing program was completed to confirm visual classification of the soils encountered. Grain size analyses, Atterberg Limits, and moisture content testing were carried out on selected samples collected from the test pits. The findings from the index testing conducted on the



## GEOTECHNICAL INVESTIGATION - WASTE ROCK STORAGE AREA DRAINAGE DITCHES – PHASE 3

### Summarized Subsurface Conditions

selected representative samples are presented on the charts and tables provided herein and in Appendix C as well as on the test pit records provided in Appendix B, where applicable.

## 3.0 SUMMARIZED SUBSURFACE CONDITIONS

The soil strata encountered during out field investigation are summarized below and described in detail on the Test Pit Records provided in Appendix B. The *Symbols and Terms used on Test Pit Records* provide a brief explanation of the terminology and graphics used by Stantec and are also provided in Appendix B.

Soil classification was based on the procedures described in ASTM D2488 (*Standard Practice for Description and Identification of Soils, Visual-Manual Procedure*) and ASTM D2487 (*Standard Practice for Classification of Soils for Engineering Purposes (Unified Soil Classification System)*).

### 3.1 SOIL AND BEDROCK

In general, the principal strata encountered at the test pit locations consisted of the following:

- Surficial vegetation and organic rootmat
- Fill consisting of sandy lean clay and Rockfill
- Silty SAND (SM)with gravel
- Glacial till
- Inferred Bedrock

A summary of the subsurface conditions encountered at the test pit locations is provided in Table 3.1.

**Table 3.1 Subsurface Conditions Summary**

Test Pit ID	Exploration Depth (m)	Thickness (m)				Depth to Refusal* (m) [EL]	Depth to Groundwater (m) [EL]
		Vegetation / Rootmat	Fill/ Rockfill	Silty Sand (SM) with gravel	Till		
TP1A	6.0	NE	4.5	1.5*	NE	NE	4.5 [121.3]
TP1B	5.4	0.48	NE	NE	4.92	4.92	NE
TP2A	4.2	0.1	NE	0.7	3.6	4.2 [120.4]	1.2 [123.4]
TP2B	5.7	NE	NE	0.4	5.3	5.3	NE
TP3A	1.4	NE	NE	0.51	0.89	1.4 [123.8]	1.0 [124.2]
TP4A	3.1	NE	NE	0.8	2.3	3.1 [124.2]	1.4 [125.9]
TP5A	4.3	0.2	NE	NE	4.1	4.1	NE
TP6A	4.7	0.1	NE	NE	4.6	4.6	NE
TP7A	5.0	0.5	NE	NE	4.5	4.5	NE





## GEOTECHNICAL INVESTIGATION - WASTE ROCK STORAGE AREA DRAINAGE DITCHES – PHASE 3

### Summarized Subsurface Conditions

Test Pit ID	Exploration Depth (m)	Thickness (m)				Depth to Refusal* (m) [EL]	Depth to Groundwater (m) [EL]
		Vegetation / Rootmat	Fill/ Rockfill	Silty Sand (SM) with gravel	Till		
* Refusal on possible boulder or inferred bedrock, EL: Elevation, NE: Not Encountered							

#### Vegetation / Rootmat

A 0.1 m to 0.5 m thick layer of Vegetation / Rootmat was observed at the surface of TP1B, TP2A, TP5A to TP7A.

#### Fill

A layer of fill was observed at the surface of TP1A. The fill was approximately 4.5m thick and consisted of alternating layers of dark grey rockfill and brown sandy lean clay. The fill is interpreted to be part of the existing west berm and swale of the existing WRSA drainage ditch.

#### Silty Sand (SM) with gravel

A layer of silty sand (SM) with gravel was encountered beneath the rockfill layer in TP1A, beneath the vegetation / rootmat in TP2A, and at the grubbed surface of TP2B, TP3A, and TP4A. The silty sand was observed to be reddish brown to orange in color and ranged in thickness from approximately 0.4 to 0.8 m at the locations where test pits were advanced below this layer. TP1A was terminated in this material and the thickness could not be determined. Moisture content determinations were found to range from 29.8 to 34.3 percent as presented on the Test Pit Records.

#### Glacial Till

A layer of glacial till (till) was encountered beneath the silty SAND (SM) in TP2A, TP2B, TP3A and TP4A, and beneath the vegetation / rootmat in TP1B, TP5A to TP7A. The till layer thickness was found to range from 0.9 m to 3.6 m at the extent of the excavations where the test pits were advanced to bedrock. Many test pits were terminated in this layer and the thickness could not be determined.

The material was found to be brown to dark brown in colour and described as ranging from sandy lean clay (CL) with varying percentages of gravel, to a clayey sand (SC) with gravel, and at some locations a silty sand (SM). Some to frequent cobbles and boulders was found to occur within the till layer. Moisture content determinations were found to range from 9.4 to 14.9 percent as presented on the Borehole Records.

Representative samples were selected for grain size analysis, and Atterberg Limits testing. The results are summarized on the Gradation Curve and Plasticity Charts presented in Appendix D



## **GEOTECHNICAL INVESTIGATION - WASTE ROCK STORAGE AREA DRAINAGE DITCHES – PHASE 3**

### Summarized Subsurface Conditions

Based on visual review including excavator performance and excavation sidewall stability, the till stratum is estimated to have a consistency / compactness of firm to hard / compact to dense.

### **3.2 GROUNDWATER CONDITIONS**

Groundwater levels were inferred from observations in the test pits. Water seepage into the test pits ranged from 1.0 to 4.5 m below the existing ground surface in four of the test pits with no ground water seepage noted in the remaining. Perched surface water was noted in the upper 0.5 metres of TP5A to TP7A.

Groundwater levels can be expected to fluctuate seasonally and in response to precipitation events, adjacent site development, and construction activity.



## GEOTECHNICAL INVESTIGATION - WASTE ROCK STORAGE AREA DRAINAGE DITCHES – PHASE 3

Discussion and Recommendations

### 4.0 DISCUSSION AND RECOMMENDATIONS

#### 4.1 GENERAL

The purpose of the geotechnical investigation was to obtain information on the subsurface conditions at the site for input into the geotechnical design and construction recommendations for the proposed WRSA expansion drainage ditch and culvert design.

In general, the subsurface conditions encountered at the test pit locations consisted of vegetation and rootmat overlying silty SAND (SM) with gravel, underlain by till and inferred bedrock. TP1A consisted of 4.5m of alternating rockfill and sandy lean clay fill as part of the existing west berm and swale of the WRSA overlying the silty SAND (SM) with gravel.

The expansion construction will consist of the following:

- grubbing for Phase 3 expansion of WRSA;
- construction of approximately 850m of perimeter ditch including approximately 350 m of exterior berm construction; and
- installation of 205m long culvert.

The anticipated conditions and recommendations have been summarized below by approximate chainage along the ditch alignment followed by general recommendations.

#### 4.2 SUMMARY OF SUBSURFACE CONDITIONS AND CONSTRUCTION WORK

##### 0+000 to 0+060 (Berm construction for ditch and tie-in)

- TP1A and TP2A are in this area;
- Berm to be constructed in this area to form the ditch which will include:
  - Construction of berm and ditch as per the design drawings.
  - Tie-in with existing ditch constructed as part of Phase I of the WRSA drainage ditch.
- Construction dewatering will likely be required during berm construction and tie-in with existing ditch berm.
- TP1A was excavated into the existing Phase I drainage ditch berm and the following is noted:
  - Surficial layer of rockfill overlying approximately 1 m of sandy lean clay fill overlying rockfill underlain by native silty sand (SM) and gravel.



## GEOTECHNICAL INVESTIGATION - WASTE ROCK STORAGE AREA DRAINAGE DITCHES – PHASE 3

### Discussion and Recommendations

- It can be inferred from the above noted observation that a rockfill berm with a clay liner and surficial rockfill erosion protection was constructed. This does not meet the Phase I design or the current Phase 3 design for the WRSA ditches.
- **Further investigation onto the Phase 1 west berm should be completed and if required modifications to the berm should be completed to meet the original design.**

#### 0+060 to 0+300 (Berm Construction for Ditch)

- TP1B and TP3A are in this area;
- Berm to be constructed in this area to form the ditch which will include:
  - Construction of berm and ditch as per the design.
- Relatively shallow inferred bedrock based on excavator refusal was encountered at TP3A at an elevation of 123.8 m. The invert of the ditch subgrade at this location is approximately 124.5 m which only provides a buffer of 0.7 m between bedrock and subgrade.
- Although relatively shallow excavations are required, construction dewatering may be required in this area, particularly from 0+240 to 0+300.

#### 0+300 to 0+336 (Scour Pad and Ditch)

- TP4A is in this area.
- Construction in this area to include:
  - Transition from berm to form the ditch to excavation below existing grade to form the ditch and construction of a scour pad.
    - Construction of berm and ditch and scour pad as per the design.
- Based on test pit information till and bedrock excavation anticipated for construction of scour pad
  - Inferred bedrock based on excavator refusal was encountered at TP4A at an elevation of 124.2 m. Scour pad subgrade is as low as elevation 122.9 m.
- Construction dewatering may be required in this area during construction of the scour pad.

#### 0+336 to 0+541 (Buried Culvert and Ditch Construction)

- TP4A, TP5A, TP6A, TP7A are in this area.
- Construction in this area to include:
  - Culvert Installation
    - Excavations in the order of 4-5 m below existing grade is anticipated.
    - Placement and backfill of culvert to design grades.
  - Ditch Construction
    - Construction of ditch as per the design. Ditch to be constructed in approved fill following backfilling of the culvert.
- Based on test pit information till and bedrock excavation anticipated for placement of culvert.
  - Excavator refusal possible boulders or inferred bedrock at 128.9 m, 127.9 m, 126.2 m in TP5A, TP6A, and TP7A, respectively.



## GEOTECHNICAL INVESTIGATION - WASTE ROCK STORAGE AREA DRAINAGE DITCHES – PHASE 3

### Discussion and Recommendations

- Excavator refusal on inferred bedrock in TP4A to the west of this area at 124.2 m.
  - Excavation subgrade below culvert ranges from 127.7 m to 128.7 m.
- Construction dewatering may be required in this area during installation of the culvert.
- Temporary excavation slopes should be monitored and maintained as described below.

#### 0+541 to 0+816 (Ditch)

- TP2B is in this area.
- Ditch construction to include:
  - Construction of ditch as per the design.
- Based on test pit information ditch to be excavated into till.

#### General Site Preparation

General site preparation requires removal of unsuitable materials i.e vegetation/rootmat, fill, loose, wet or other deleterious material prior to construction of ditch materials.

## 4.3 RECOMMENDATIONS

### 4.3.1 Erosion and Sediment Control

Refer to the Erosion and Sediment Control Plan (Stantec 2010) developed for the Touquoy site for best management practices for construction works related to erosion and sediment control at the site. To align with the key principle of the plan the construction work shall minimize the amount of exposed soil as well as the time of the exposure to minimize erosion and sediment transport.

### 4.3.2 Temporary Excavations Slopes

Short term excavation slopes within existing native soil layers should be maintained at slopes no steeper than 2.0H:1V. Excavations in bedrock should be maintained at minimum of 1H:1V. Safe excavation slopes are the responsibility of the earthworks contractor. If an excavation cannot be properly sloped or benched during installation of the culvert, the contractor should install an engineered shoring system to safely support the temporary excavation.

Temporary slopes should be protected from surface-runoff erosion by means of berms and swales located along the top of the slope and by means of plastic sheeting placed over the slope. Soil stockpiles should not be located within 1.5 times the height of the excavation depth to avoid surcharging the excavation slopes. Slopes should be routinely inspected by geotechnical personnel for signs of instability and flattened, if necessary.



## GEOTECHNICAL INVESTIGATION - WASTE ROCK STORAGE AREA DRAINAGE DITCHES – PHASE 3

### Discussion and Recommendations

#### 4.3.3 Bedrock / Till Excavation

It is anticipated the bedrock removal and/or excavation into firm to hard till may be required in some areas for the installation of the 750 mm Culvert and construction of the scour pad.

It may be feasible to remove some of the upper rock (up to a depth of 1 m) by rock breakers. The contractor selected to complete this work should be responsible for determining the means and methods for bedrock removal.

The till was noted to be firm to hard and contain some to frequent cobbles and boulders. It is the responsibility of the contractor to determine the methods for excavation in the till.

#### 4.3.4 Construction Dewatering

Due to the planned excavation being potentially beneath the groundwater table in some sections, water infiltration could occur in excavations during construction. Dewatering should be expected to maintain excavations in a dry condition. Construction dewatering may be accomplished by using traditional sump and pump techniques.

#### 4.3.5 Field Inspection

It is recommended that construction work should be monitored full time by experienced geotechnical personnel, during removal of unsuitable material, subgrade preparation and placement of clay liner, geotextile and rip rap.

#### 4.3.6 Winter Construction

Should construction be completed during the winter months, care should be taken that excavations and exposed subgrade should be maintained in a dry and unfrozen condition throughout construction. Soils that become disturbed/softened during construction should be over-excavated and replaced with compacted clay till borrow.

Additional recommendations for winter construction can be provided, if requested.



## GEOTECHNICAL INVESTIGATION - WASTE ROCK STORAGE AREA DRAINAGE DITCHES – PHASE 3

Closing

### 5.0 CLOSING

Use of this report is subject to the Statement of General Conditions in Appendix A. It is the responsibility of Atlantic Mining NS Inc., identified as “the Client” within the Statement of General Conditions, and its agents to review the conditions and to notify Stantec should conditions not be satisfied. The Statement of General Conditions addresses the following:

- Use of the report
- Basis of the report
- Standard of care
- Interpretation of site conditions
- Varying or unexpected site conditions
- Planning, design or construction

We trust that the information contained in this report is adequate for your present purposes. If you have questions about the contents of this factual report, or if we can be of further assistance, please do not hesitate to contact the undersigned at your convenience.



**GEOTECHNICAL INVESTIGATION - WASTE ROCK STORAGE AREA DRAINAGE DITCHES –  
PHASE 3**

Appendix A Statement of General Conditions

**Appendix A STATEMENT OF GENERAL CONDITIONS**

**A.1 STATEMENT OF GENERAL CONDITIONS**





## STATEMENT OF GENERAL CONDITIONS

USE OF THIS REPORT: This report has been prepared for the sole benefit of the Client or its agent and may not be used by any third party without the express written consent of Stantec Consulting Ltd. and the Client. Any use which a third party makes of this report is the responsibility of such third party.

BASIS OF THE REPORT: The information, opinions, and/or recommendations made in this report are in accordance with Stantec Consulting Ltd.'s present understanding of the site specific project as described by the Client. The applicability of these is restricted to the site conditions encountered at the time of the investigation or study. If the proposed site specific project differs or is modified from what is described in this report or if the site conditions are altered, this report is no longer valid unless Stantec Consulting Ltd. is requested by the Client to review and revise the report to reflect the differing or modified project specifics and/or the altered site conditions.

STANDARD OF CARE: Preparation of this report, and all associated work, was carried out in accordance with the normally accepted standard of care in the state or province of execution for the specific professional service provided to the Client. No other warranty is made.

INTERPRETATION OF SITE CONDITIONS: Soil, rock, or other material descriptions, and statements regarding their condition, made in this report are based on site conditions encountered by Stantec Consulting Ltd. at the time of the work and at the specific testing and/or sampling locations. Classifications and statements of condition have been made in accordance with normally accepted practices which are judgmental in nature; no specific description should be considered exact, but rather reflective of the anticipated material behavior. Extrapolation of in situ conditions can only be made to some limited extent beyond the sampling or test points. The extent depends on variability of the soil, rock and groundwater conditions as influenced by geological processes, construction activity, and site use.

VARYING OR UNEXPECTED CONDITIONS: Should any site or subsurface conditions be encountered that are different from those described in this report or encountered at the test locations, Stantec Consulting Ltd. must be notified immediately to assess if the varying or unexpected conditions are substantial and if reassessments of the report conclusions or recommendations are required. Stantec Consulting Ltd. will not be responsible to any party for damages incurred as a result of failing to notify Stantec Consulting Ltd. that differing site or subsurface conditions are present upon becoming aware of such conditions.

PLANNING, DESIGN, OR CONSTRUCTION: Development or design plans and specifications should be reviewed by Stantec Consulting Ltd., sufficiently ahead of initiating the next project stage (property acquisition, tender, construction, etc), to confirm that this report completely addresses the elaborated project specifics and that the contents of this report have been properly interpreted. Specialty quality assurance services (field observations and testing) during construction are a necessary part of the evaluation of sub-subsurface conditions and site preparation works. Site work relating to the recommendations included in this report should only be carried out in the presence of a qualified geotechnical engineer; Stantec Consulting Ltd. cannot be responsible for site work carried out without being present.

**GEOTECHNICAL INVESTIGATION - WASTE ROCK STORAGE AREA DRAINAGE DITCHES –  
PHASE 3**

Appendix B Drawings

**Appendix B DRAWINGS**

**B.1 DRAWING SK-86: WASTE ROCK STORAGE AREA PHASE 3 DITCH  
DESIGN**



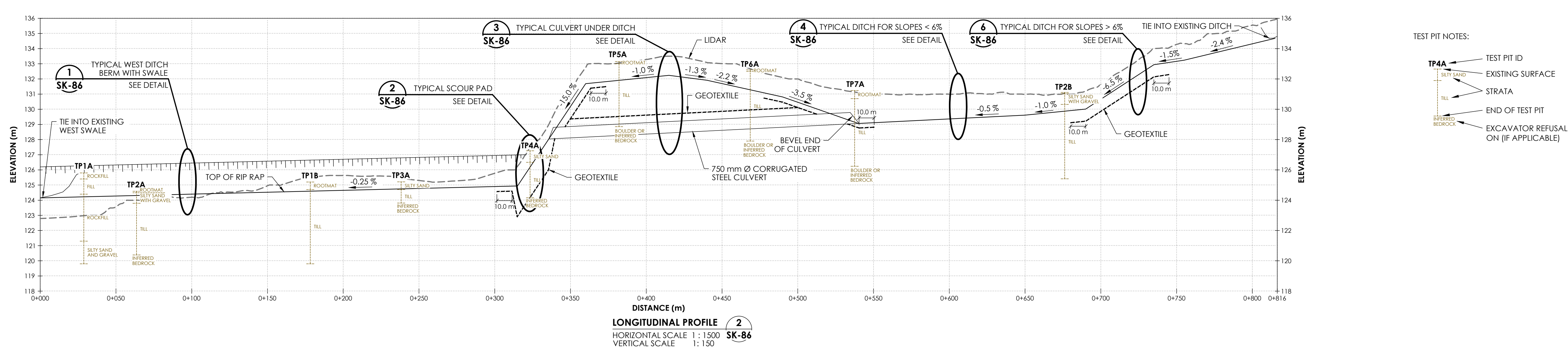
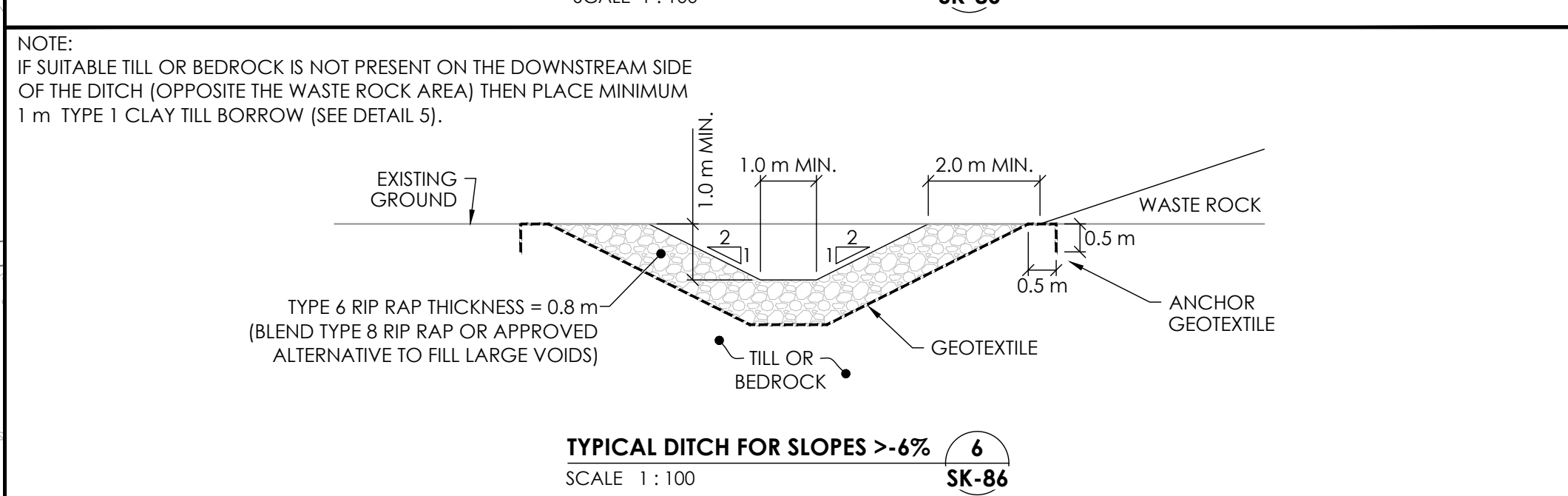
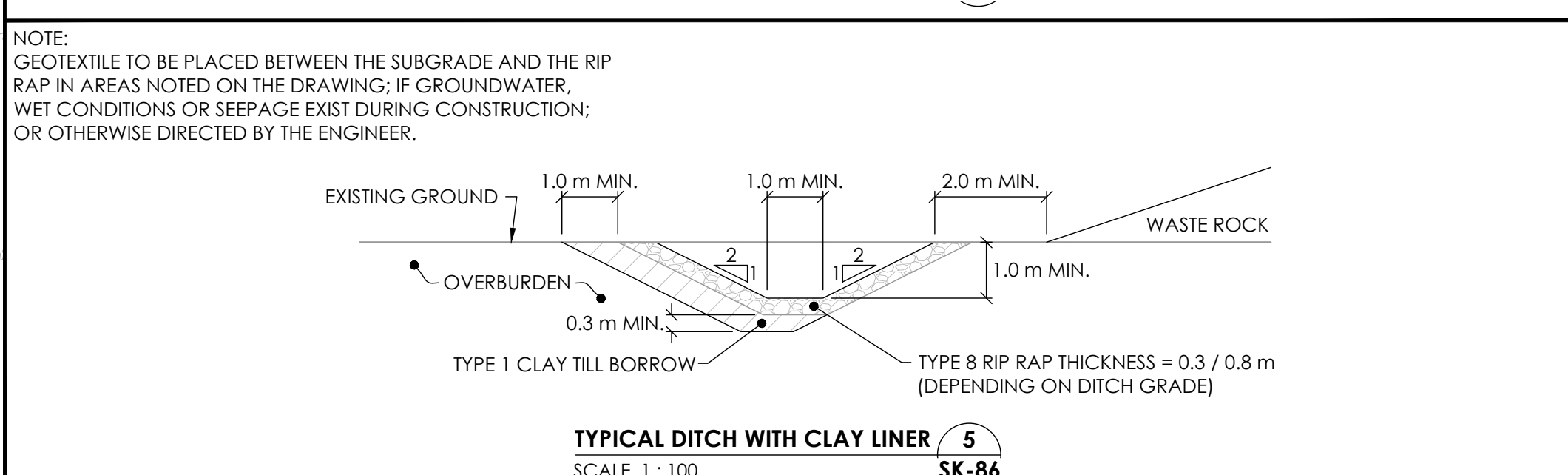
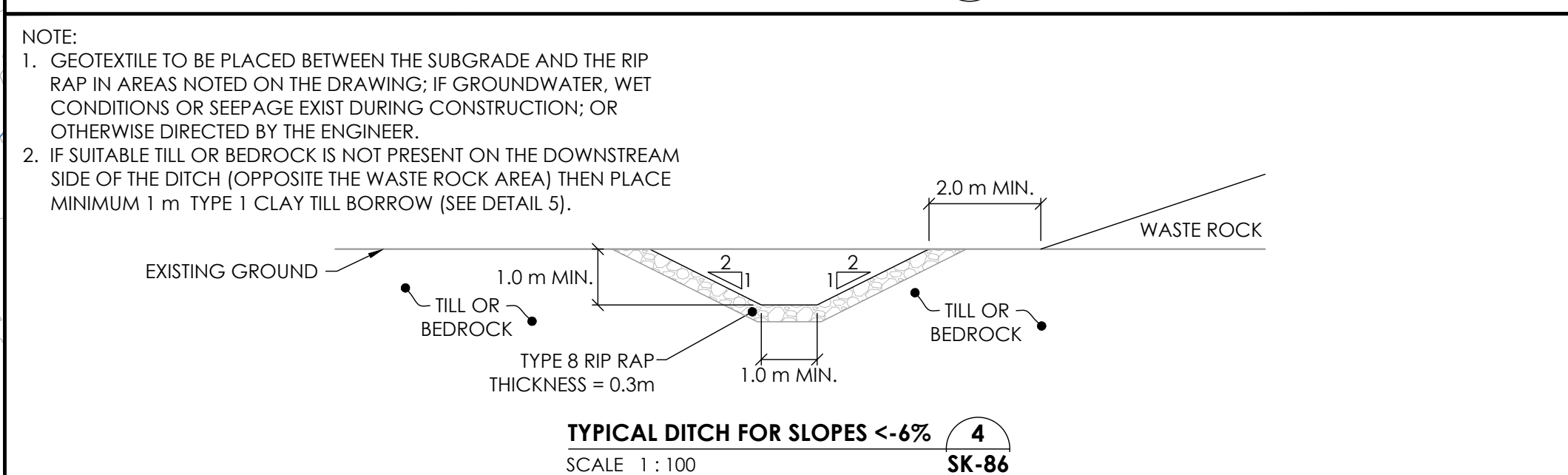
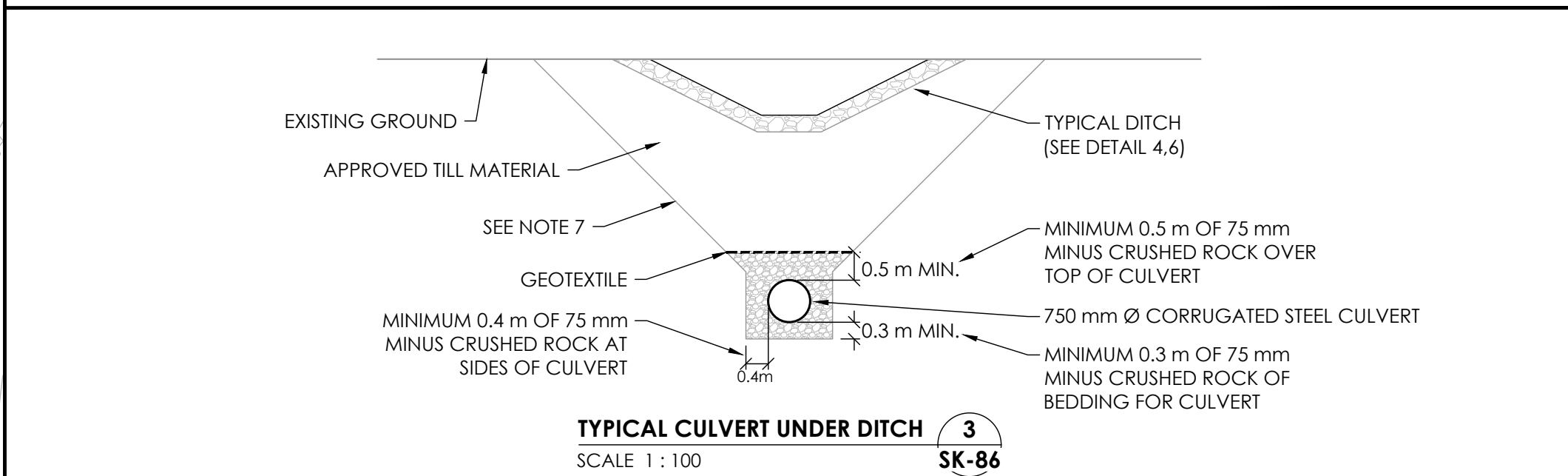
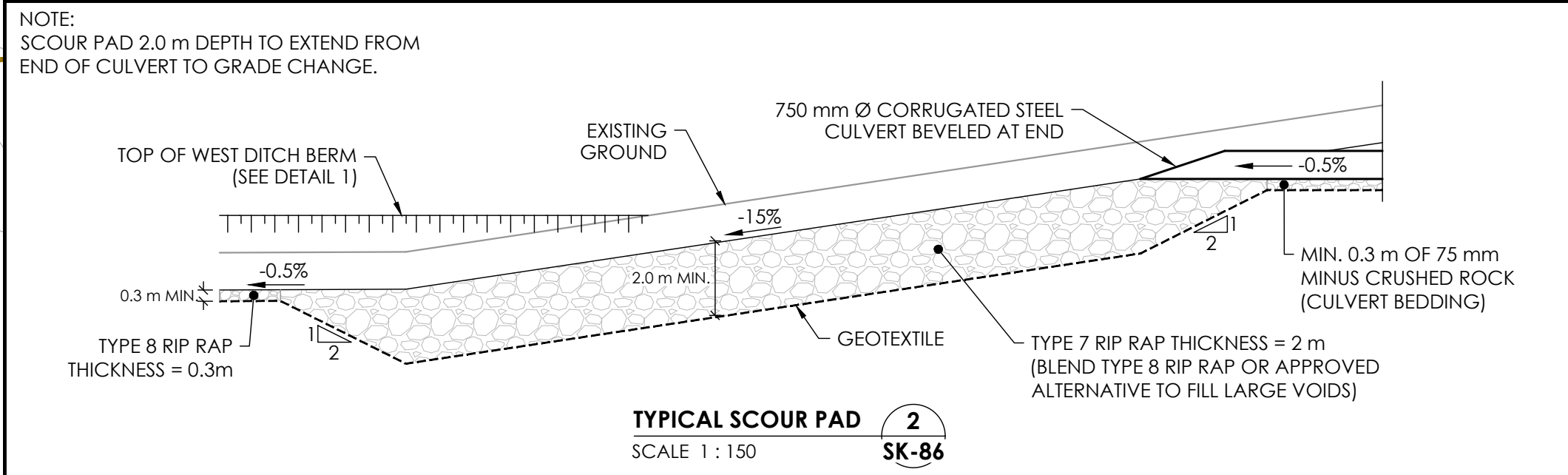
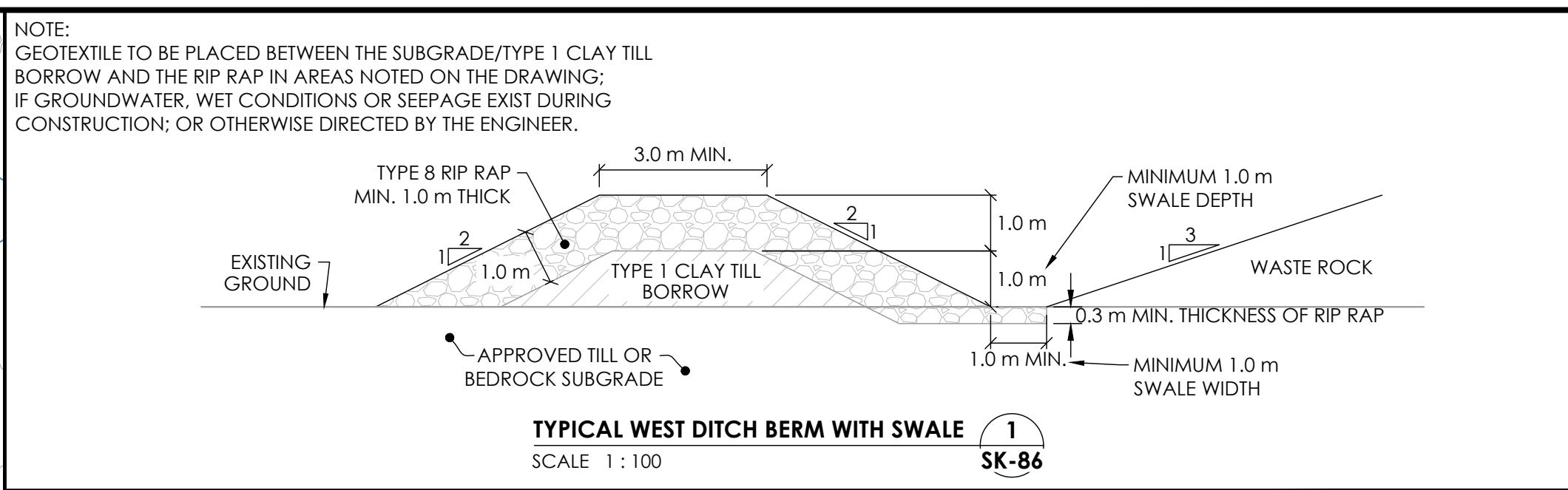
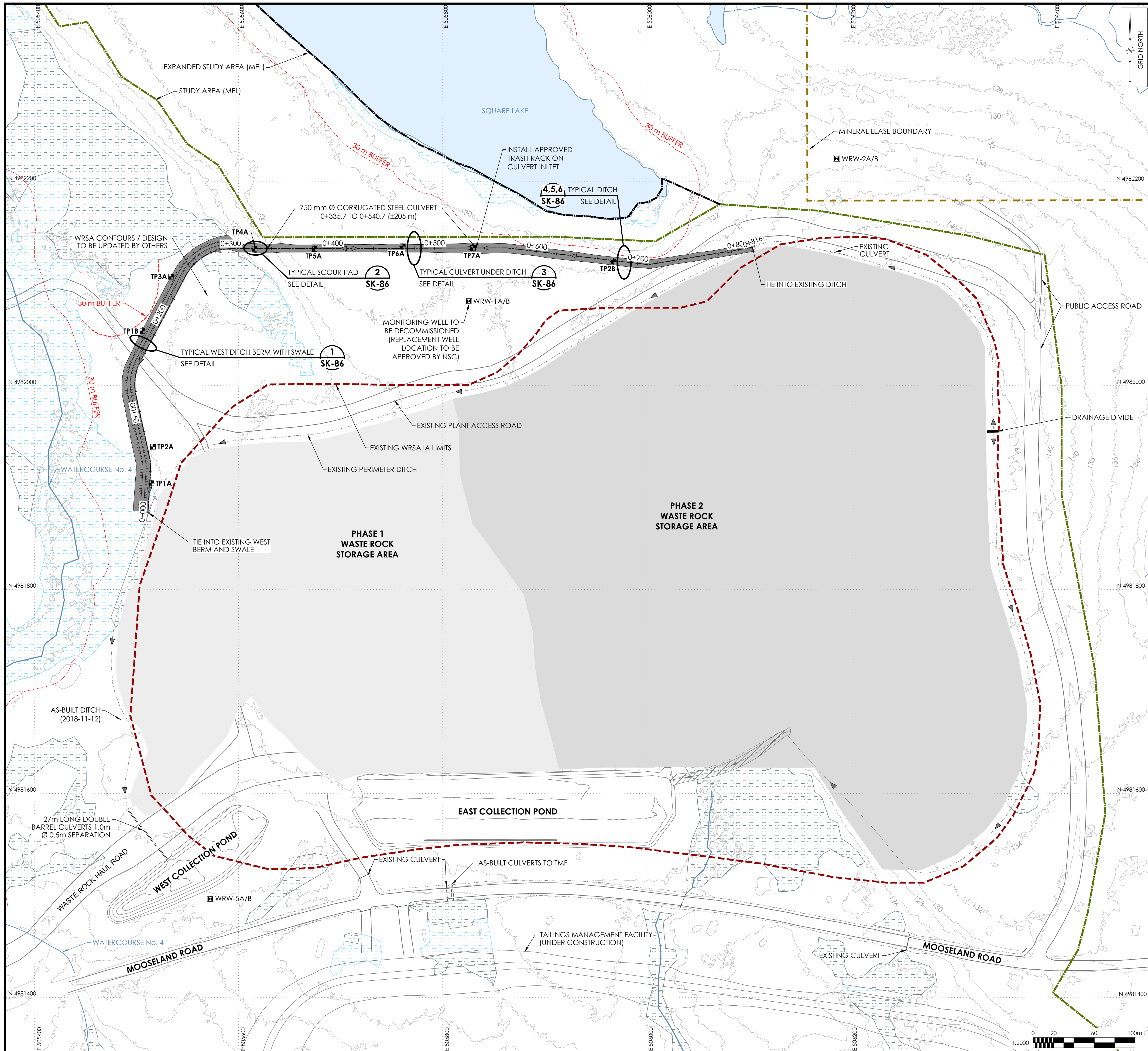

Copyright Reserved  
The Contractor shall verify and be responsible for all dimensions. DO NOT scale the drawing - any errors or omissions shall be reported to Stantec without delay.  
The Copyrights to all designs and drawings are the property of Stantec. Reproduction or use for any purpose other than that authorized by Stantec is forbidden.

Legend

- LI-DAR, 2010
- EXISTING ROAD
- EXISTING WATERCOURSE
- WATERBODY
- WETLAND
- PERMITTED WETLAND ALTERATION
- STUDY AREA (MCCALLUM ENVIRONMENTAL LTD.)
- EXPANDED STUDY AREA (MCCALLUM ENVIRONMENTAL LTD.)
- MINERAL LEASE BOUNDARY
- EXISTING WRSA IA LIMITS
- EXISTING PERIMETER DITCH CENTERLINE
- 30 m BUFFER
- PROPOSED DITCH FOOTPRINT
- CENTERLINE OF PROPOSED DITCH
- DITCH FLOW DIRECTION
- GROUNDWATER MONITORING WELL
- TEST PIT

Notes

- BACKGROUND TOPOGRAPHY SHOWN IS BASED ON LI-DAR DATA PROVIDED BY CONESTOGA-WOODS & ASSOCIATES (2010). ACTUAL FIELD CONDITIONS MAY VARY.
- EXISTING DITCHES AND PILES BASED ON SURVEY DATA PROVIDED BY ATLANTIC SOIL CORPORATION.
- PLEASE REFER TO THE EROSION AND SEDIMENT CONTROL PLAN (STANTEC 2010) DEVELOPED FOR THE TOUQUOY SITE FOR BEST MANAGEMENT PRACTICES FOR CONSTRUCTION WORKS RELATED TO EROSION AND SEDIMENT CONTROL. AT THE SITE, TO ACHIEVE WITH THE KEY PRINCIPLES OF THE PLAN THE CONSTRUCTION WORK SHALL MINIMIZE THE AMOUNT OF EXPOSED SOIL AS WELL AS THE TIME OF THE EXPOSURE TO WASHING EROSION AND SEDIMENT TRANSPORT. IF REQUIRED, EXPOSED SOIL SHALL BE COVERED WITH NON-ERODIBLE MATERIALS SEALED WITH A FLEXIBLE TARPED BEFORE EACH DAY'S CONSTRUCTION DAY.
- ADDITIONAL BEST MANAGEMENT PRACTICES MAY NEED TO BE IMPLEMENTED TO MINIMIZE EROSION AND SEDIMENT TRANSPORT FROM THE SITE. THESE SHALL BE IMPLEMENTED AS REQUESTED BY ATLANTIC MINING NOVA SCOTIA OR DESIGNATED DURING CONSTRUCTION.
- GRADING WILL BE REQUIRED TO MEET SUBGRADE ELEVATION AND ACHIEVE MINIMUM OF -0.2% GRADE SHOWN ON DRAWING. THIS MAY INCLUDE COMMON EXCAVATION, ROCK EXCAVATION AND BERM CONSTRUCTION.
- ROUTINE CLEAN-OUT OF DITCH MAY BE REQUIRED TO REMOVE SEDIMENT.
- TEMPORARY STABILITY OF EXCAVATION IS THE RESPONSIBILITY OF THE CONTRACTOR.

COLLECTION POND	CATCHMENT AREA BASED ON TOE SEEPAGE	CATCHMENT AREA BASED ON FINAL WASTE ROCK SURFACE
WEST	242,700 m <sup>2</sup>	241,600 m <sup>2</sup>
EAST	250,840 m <sup>2</sup>	232,135 m <sup>2</sup>

ISSUED FOR TENDER

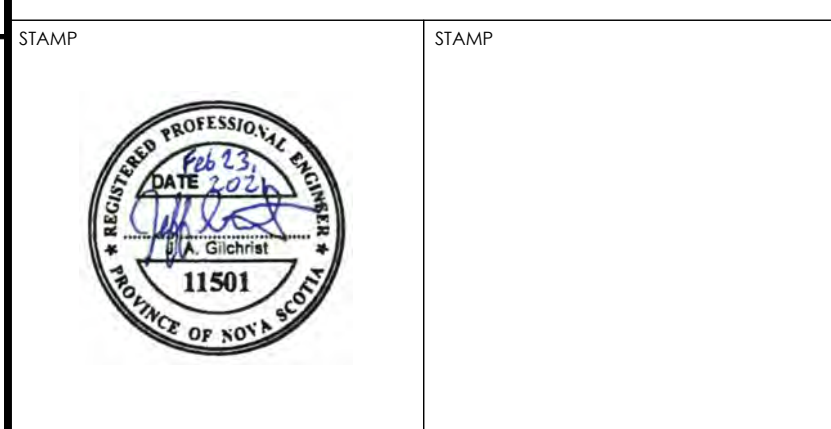

NO.	DETAILS	BY	APPD.	DATE
2	TEST PITS ADDED TO PLAN VIEW AND LONGITUDINAL PROFILE	JG	PD	2021-02-23
1	DITCH ALIGNMENT CHANGE ISSUED FOR REVIEW	JG	PD	2020-12-21
0	ISSUED FOR REVIEW NOT FOR CONSTRUCTION	JG	PD	2020-04-23

CLIENT: ATLANTIC MINING NS INC.

PROJECT: TOUQUOY GOLD PROJECT TAILINGS MANAGEMENT FACILITY

PROJECT LOCATION: HALIFAX COUNTY, NOVA SCOTIA

JOB NO.	SCALE	DATE
121619250	AS SHOWN	2021-02-23

DRAWN BY:	DESIGNED BY:	APPROVED BY:
JL	JG/RJ	PD

DRAWING TITLE: WASTE ROCK STORAGE AREA PHASE 3 DITCH DESIGN

DRAWING NO.	REVISION NO.
SK-86	2

**GEOTECHNICAL INVESTIGATION - WASTE ROCK STORAGE AREA DRAINAGE DITCHES –  
PHASE 3**

Appendix C Test Pit Records

**Appendix C TEST PIT RECORDS**

**C.1 SYMBOLS AND TERMS USED ON BOREHOLE AND TEST PIT  
RECORDS**

**C.2 TEST PIT RECORDS: TP1A TO TP7A**



## SYMBOLS AND TERMS USED ON BOREHOLE AND TEST PIT RECORDS

### SOIL DESCRIPTION

#### Terminology describing common soil genesis:

<i>Rootmat</i>	- vegetation, roots and moss with organic matter and topsoil typically forming a mattress at the ground surface
<i>Topsoil</i>	- mixture of soil and humus capable of supporting vegetative growth
<i>Peat</i>	- mixture of visible and invisible fragments of decayed organic matter
<i>Till</i>	- unstratified glacial deposit which may range from clay to boulders
<i>Fill</i>	- material below the surface identified as placed by humans (excluding buried services)

#### Terminology describing soil structure:

<i>Desiccated</i>	- having visible signs of weathering by oxidization of clay minerals, shrinkage cracks, etc.
<i>Fissured</i>	- having cracks, and hence a blocky structure
<i>Varved</i>	- composed of regular alternating layers of silt and clay
<i>Stratified</i>	- composed of alternating successions of different soil types, e.g. silt and sand
<i>Layer</i>	- > 75 mm in thickness
<i>Seam</i>	- 2 mm to 75 mm in thickness
<i>Parting</i>	- < 2 mm in thickness

#### Terminology describing soil types:

The classification of soil types are made on the basis of grain size and plasticity in accordance with the Unified Soil Classification System (USCS) (ASTM D 2487 or D 2488) which excludes particles larger than 75 mm. For particles larger than 75 mm, and for defining percent clay fraction in hydrometer results, definitions proposed by Canadian Foundation Engineering Manual, 4<sup>th</sup> Edition are used. The USCS provides a group symbol (e.g. SM) and group name (e.g. silty sand) for identification.

#### Terminology describing cobbles, boulders, and non-matrix materials (organic matter or debris):

Terminology describing materials outside the USCS, (e.g. particles larger than 75 mm, visible organic matter, and construction debris) is based upon the proportion of these materials present:

<i>Trace, or occasional</i>	Less than 10%
<i>Some</i>	10-20%
<i>Frequent</i>	> 20%

#### Terminology describing compactness of cohesionless soils:

The standard terminology to describe cohesionless soils includes compactness (formerly "relative density"), as determined by the Standard Penetration Test (SPT) N-Value - also known as N-Index. The SPT N-Value is described further on page 3. A relationship between compactness condition and N-Value is shown in the following table.

Compactness Condition	SPT N-Value
<i>Very Loose</i>	<4
<i>Loose</i>	4-10
<i>Compact</i>	10-30
<i>Dense</i>	30-50
<i>Very Dense</i>	>50

#### Terminology describing consistency of cohesive soils:

The standard terminology to describe cohesive soils includes the consistency, which is based on undrained shear strength as measured by *in situ* vane tests, penetrometer tests, or unconfined compression tests. Consistency may be crudely estimated from SPT N-Value based on the correlation shown in the following table (Terzaghi and Peck, 1967). The correlation to SPT N-Value is used with caution as it is only very approximate.

Consistency	Undrained Shear Strength		Approximate SPT N-Value
	kips/sq.ft.	kPa	
<i>Very Soft</i>	<0.25	<12.5	<2
<i>Soft</i>	0.25 - 0.5	12.5 - 25	2-4
<i>Firm</i>	0.5 - 1.0	25 - 50	4-8
<i>Stiff</i>	1.0 - 2.0	50 - 100	8-15
<i>Very Stiff</i>	2.0 - 4.0	100 - 200	15-30
<i>Hard</i>	>4.0	>200	>30

## ROCK DESCRIPTION

Except where specified below, terminology for describing rock is as defined by the International Society for Rock Mechanics (ISRM) 2007 publication "The Complete ISRM Suggested Methods for Rock Characterization, Testing and Monitoring: 1974-2006"

### Terminology describing rock quality:

RQD	Rock Mass Quality
0-25	Very Poor Quality
25-50	Poor Quality
50-75	Fair Quality
75-90	Good Quality
90-100	Excellent Quality

Alternate (Colloquial) Rock Mass Quality	
Very Severely Fractured	Crushed
Severely Fractured	Shattered or Very Blocky
Fractured	Blocky
Moderately Jointed	Sound
Intact	Very Sound

**RQD (Rock Quality Designation)** denotes the percentage of intact and sound rock retrieved from a borehole of any orientation. All pieces of intact and sound rock core equal to or greater than 100 mm (4 in.) long are summed and divided by the total length of the core run. RQD is determined in accordance with ASTM D6032.

**SCR (Solid Core Recovery)** denotes the percentage of solid core (cylindrical) retrieved from a borehole of any orientation. All pieces of solid (cylindrical) core are summed and divided by the total length of the core run (It excludes all portions of core pieces that are not fully cylindrical as well as crushed or rubble zones).

**Fracture Index (FI)** is defined as the number of naturally occurring fractures within a given length of core. The Fracture Index is reported as a simple count of natural occurring fractures.

### Terminology describing rock with respect to discontinuity and bedding spacing:

Spacing (mm)	Discontinuities	Bedding
>6000	Extremely Wide	-
2000-6000	Very Wide	Very Thick
600-2000	Wide	Thick
200-600	Moderate	Medium
60-200	Close	Thin
20-60	Very Close	Very Thin
<20	Extremely Close	Laminated
<6	-	Thinly Laminated

### Terminology describing rock strength:

Strength Classification	Grade	Unconfined Compressive Strength (MPa)
Extremely Weak	R0	<1
Very Weak	R1	1 – 5
Weak	R2	5 – 25
Medium Strong	R3	25 – 50
Strong	R4	50 – 100
Very Strong	R5	100 – 250
Extremely Strong	R6	>250

### Terminology describing rock weathering:

Term	Symbol	Description
Fresh	W1	No visible signs of rock weathering. Slight discoloration along major discontinuities
Slightly	W2	Discoloration indicates weathering of rock on discontinuity surfaces. All the rock material may be discolored.
Moderately	W3	Less than half the rock is decomposed and/or disintegrated into soil.
Highly	W4	More than half the rock is decomposed and/or disintegrated into soil.
Completely	W5	All the rock material is decomposed and/or disintegrated into soil. The original mass structure is still largely intact.
Residual Soil	W6	All the rock converted to soil. Structure and fabric destroyed.

## STRATA PLOT

Strata plots symbolize the soil or bedrock description. They are combinations of the following basic symbols. The dimensions within the strata symbols are not indicative of the particle size, layer thickness, etc.

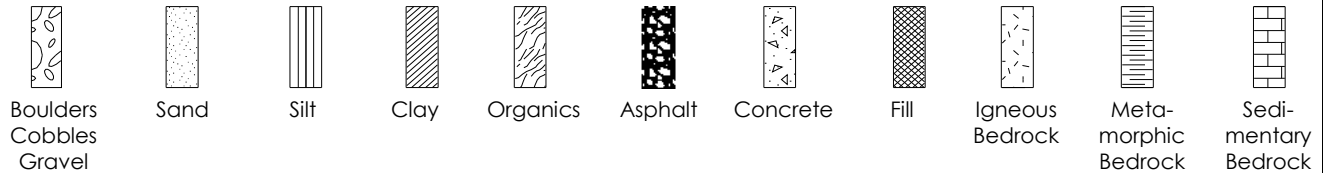

## SAMPLE TYPE

SS	Split spoon sample (obtained by performing the Standard Penetration Test)
ST	Shelby tube or thin wall tube
DP	Direct-Push sample (small diameter tube sampler hydraulically advanced)
PS	Piston sample
BS	Bulk sample
HQ, NQ, BQ, etc.	Rock core samples obtained with the use of standard size diamond coring bits.

## WATER LEVEL MEASUREMENT

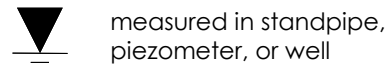

measured in standpipe, piezometer, or well



inferred

## RECOVERY

For soil samples, the recovery is recorded as the length of the soil sample recovered. For rock core, recovery is defined as the total cumulative length of all core recovered in the core barrel divided by the length drilled and is recorded as a percentage on a per run basis.

## N-VALUE

Numbers in this column are the field results of the Standard Penetration Test: the number of blows of a 140 pound (63.5 kg) hammer falling 30 inches (760 mm), required to drive a 2 inch (50.8 mm) O.D. split spoon sampler one foot (300 mm) into the soil. In accordance with ASTM D1586, the N-Value equals the sum of the number of blows (N) required to drive the sampler over the interval of 6 to 18 in. (150 to 450 mm). However, when a 24 in. (610 mm) sampler is used, the number of blows (N) required to drive the sampler over the interval of 12 to 24 in. (300 to 610 mm) may be reported if this value is lower. For split spoon samples where insufficient penetration was achieved and N-Values cannot be presented, the number of blows are reported over sampler penetration in millimetres (e.g. 50/75). Some design methods make use of N-values corrected for various factors such as overburden pressure, energy ratio, borehole diameter, etc. No corrections have been applied to the N-values presented on the log.

## DYNAMIC CONE PENETRATION TEST (DCPT)

Dynamic cone penetration tests are performed using a standard 60 degree apex cone connected to 'A' size drill rods with the same standard fall height and weight as the Standard Penetration Test. The DCPT value is the number of blows of the hammer required to drive the cone one foot (300 mm) into the soil. The DCPT is used as a probe to assess soil variability.

## OTHER TESTS

S	Sieve analysis
H	Hydrometer analysis
k	Laboratory permeability
y	Unit weight
G <sub>s</sub>	Specific gravity of soil particles
CD	Consolidated drained triaxial
CU	Consolidated undrained triaxial with pore pressure measurements
UU	Unconsolidated undrained triaxial
DS	Direct Shear
C	Consolidation
Q <sub>u</sub>	Unconfined compression
I <sub>p</sub>	Point Load Index (I <sub>p</sub> on Borehole Record equals I <sub>p</sub> (50) in which the index is corrected to a reference diameter of 50 mm)

	Single packer permeability test; test interval from depth shown to bottom of borehole
	Double packer permeability test; test interval as indicated
	Falling head permeability test using casing
	Falling head permeability test using well point or piezometer



# TEST PIT RECORD

# TP1A

CLIENT ATLANTIC MINING NOVA SCOTIA INC.PROJECT No. 121619250LOCATION WRS - TOUQUOY GOLD MINE MOOSE RIVER, NOVA SCOTIATEST PIT No. TP1ADATES: DUG 2021-01-07 WATER LEVEL 4.5m BGSDATUM Geodetic

DEPTH (m)	ELEVATION (m)	SOIL DESCRIPTION	STRATA PLOT	WATER LEVEL	TYPE	NUMBER	REMARKS
0	125.80	ROCKFILL					
	125.4	FILL: brown sandy lean clay					
1	124.4	ROCKFILL					
5	121.3	Reddish brown silty SAND (SM) with gravel					
6	119.8	End of Test Pit at 6.0 m			BS	1	
7							
8							







# TEST PIT RECORD

# TP1B

CLIENT ATLANTIC MINING NOVA SCOTIA INC.PROJECT No. 121619250LOCATION WRS - TOUQUOY GOLD MINE MOOSE RIVER, NOVA SCOTIATEST PIT No. TP1BDATES: DUG 2021-01-25 WATER LEVEL Not encounteredDATUM Geodetic

DEPTH (m)	ELEVATION (m)	SOIL DESCRIPTION	STRATA PLOT	WATER LEVEL	TYPE	NUMBER	REMARKS
0	125.20						
		VEGETATION / ROOTMAT					
	124.7						
1		Brown to dark brown sandy lean clay (CL) TILL -trace gravel and cobbles			BS	1	Visual Observations: Degree of consistency: Hard
2							
3	122.6	-increased cobbles at layer 2.4 m to 2.6 m					
4							
5	120.6	-increased cobbles at layer 4.4 m to 4.6 m			BS	2	
6							
7	119.8	End of Test Pit at 5.4 m					
8							



# TEST PIT RECORD

# TP2A

CLIENT ATLANTIC MINING NOVA SCOTIA INC.PROJECT No. 121619250LOCATION WRSA - TOUQUOY GOLD MINE MOOSE RIVER, NOVA SCOTIATEST PIT No. TP2ADATES: DUG 2021-01-07 WATER LEVEL 1.2m BGSDATUM Geodetic



DEPTH (m)	ELEVATION (m)	SOIL DESCRIPTION	STRATA PLOT	WATER LEVEL	TYPE	NUMBER	REMARKS
0	124.59						
	124.5	VEGETATION / ROOTMAT					
		Reddish brown silty SAND (SM) with gravel			BS	1	w = 34.3%
	123.8						
1		Dark brown to grey clayey sand (SC) with gravel TILL -frequent cobbles and boulders			BS	2	w = 14.2%
2							
3							
4							
	120.4				BS	3	w = 13.1%
		Excavator refusal on <i>Inferred</i> BEDROCK					
		End of Test Pit at 4.2 m					
5							
6							
7							
8							



# TEST PIT RECORD

# TP2B

CLIENT ATLANTIC MINING NOVA SCOTIA INC.PROJECT No. 121619250LOCATION WRSA - TOUQUOY GOLD MINE MOOSE RIVER, NOVA SCOTIATEST PIT No. TP2BDATES: DUG 2021-01-25 WATER LEVEL Not encounteredDATUM Geodetic



DEPTH (m)	ELEVATION (m)	SOIL DESCRIPTION	STRATA PLOT	WATER LEVEL	TYPE	NUMBER	REMARKS
0	131.11						
		Reddish brown silty SAND (SM)			BS	1	
	130.7						
1		Dark brown sandy lean clay (CL) to sandy lean clay (CL) with gravel TILL -trace cobbles and boulders					
2							
3							
4	127.0						
		-increased boulders and cobbles, 3.8 m to 4.1 m					
5							Visual Observations: Degree of consistency: Hard
6	125.4						
		End of Test Pit at 5.7 m					
7							
8							



# TEST PIT RECORD

# TP3A

CLIENT ATLANTIC MINING NOVA SCOTIA INC.PROJECT No. 121619250LOCATION WRSR - TOUQUOY GOLD MINE MOOSE RIVER, NOVA SCOTIATEST PIT No. TP3ADATES: DUG 2021-01-25 WATER LEVEL 1.0m BGSDATUM Geodetic

DEPTH (m)	ELEVATION (m)	SOIL DESCRIPTION	STRATA PLOT	WATER LEVEL	TYPE	NUMBER	REMARKS
0	125.21						
		Orange to brown oxidized silty SAND (SM)			BS	1	
	124.7						
		Light brown silty sand (SM) TILL -minor silt seams					
1	124.2						
		Brown clayey sand (SC) with gravel TILL			BS	2	
	123.8						
2		Excavator refusal on <i>Inferred</i> BEDROCK					
		End of Test Pit at 1.4 m					
3							
4							
5							
6							
7							
8							



# TEST PIT RECORD

# TP4A

CLIENT ATLANTIC MINING NOVA SCOTIA INC.PROJECT No. 121619250LOCATION WRSA - TOUQUOY GOLD MINE MOOSE RIVER, NOVA SCOTIATEST PIT No. TP4ADATES: DUG 2021-01-07 WATER LEVEL 1.4m BGSDATUM Geodetic

DEPTH (m)	ELEVATION (m)	SOIL DESCRIPTION	STRATA PLOT	WATER LEVEL	TYPE	NUMBER	REMARKS
0	127.26						
		Reddish brown silty SAND (SM) with gravel			BS	1	w = 29.8%
	126.5						
1		Brown sandy lean clay (CL) with gravel to clayey sand (SC) with gravel TILL -frequent cobbles and boulders -gravel seam at 1.4m			BS	2	w = 11.4%
2							
3	124.2				BS	3	w = 14.9%
		Excavator refusal on <i>Inferred</i> BEDROCK  End of Test Pit at 3.1m					
4							
5							
6							
7							
8							



# TEST PIT RECORD

# TP5A

CLIENT ATLANTIC MINING NOVA SCOTIA INC.PROJECT No. 121619250LOCATION WRS - TOUQUOY GOLD MINE MOOSE RIVER, NOVA SCOTIATEST PIT No. TP5ADATES: DUG 2021-01-07 WATER LEVEL Not encounteredDATUM Geodetic

DEPTH (m)	ELEVATION (m)	SOIL DESCRIPTION	STRATA PLOT	WATER LEVEL	TYPE	NUMBER	REMARKS
0	133.15						
	133.0	VEGETATION / ROOTMAT					
		Dark brown sandy lean clay (CL) with gravel TILL -some cobbles and boulders					
					BS	1	w = 13.6%
					BS	2	Visual Observations: Degree of consistency: Stiff to hard w = 9.4%
	128.9	Excavator refusal on boulders or <i>Inferred</i> BEDROCK  End of Test Pit at 4.3 m					
5							
6							
7							
8							



# TEST PIT RECORD

# TP6A

CLIENT ATLANTIC MINING NOVA SCOTIA INC.PROJECT No. 121619250LOCATION WRS - TOUQUOY GOLD MINE MOOSE RIVER, NOVA SCOTIATEST PIT No. TP6ADATES: DUG 2021-01-07 WATER LEVEL Not encounteredDATUM Geodetic

DEPTH (m)	ELEVATION (m)	SOIL DESCRIPTION	STRATA PLOT	WATER LEVEL	TYPE	NUMBER	REMARKS
0	132.60						
	132.5	VEGETATION / ROOTMAT					
		Brown sandy lean clay (CL) with gravel to sandy lean clay (CL) TILL -some cobbles and boulders					
					BS	1	Visual Observations: Degree of consistency: Very stiff to hard w = 11.7%
					BS	2	w = 11.7%
	127.9	Excavator refusal on boulders or <i>Inferred</i> BEDROCK					
		End of Test Pit at 4.7 m					
8							



# TEST PIT RECORD

# TP7A

CLIENT ATLANTIC MINING NOVA SCOTIA INC.PROJECT No. 121619250LOCATION WRS - TOUQUOY GOLD MINE MOOSE RIVER, NOVA SCOTIATEST PIT No. TP7ADATES: DUG 2021-01-07 WATER LEVEL Not encounteredDATUM Geodetic

DEPTH (m)	ELEVATION (m)	SOIL DESCRIPTION	STRATA PLOT	WATER LEVEL	TYPE	NUMBER	REMARKS
0	131.24	VEGETATION / ROOTMAT					
1	130.7	Brown sandy lean clay (CL) TILL -some cobbles and boulders			BS	1	Visual Observations: Degree of consistency: Firm to stiff w = 13.7%
5	126.2	Excavator refusal on boulders or <i>Inferred</i> BEDROCK  End of Test Pit at 5.0 m			BS	2	w = 10.7%
6							
7							
8							



**GEOTECHNICAL INVESTIGATION - WASTE ROCK STORAGE AREA DRAINAGE DITCHES –  
PHASE 3**

Appendix D Laboratory Testing

**Appendix D LABORATORY TESTING**

**D.1 GRADATION CURVES**

**D.2 ATTERBERG LIMITS**



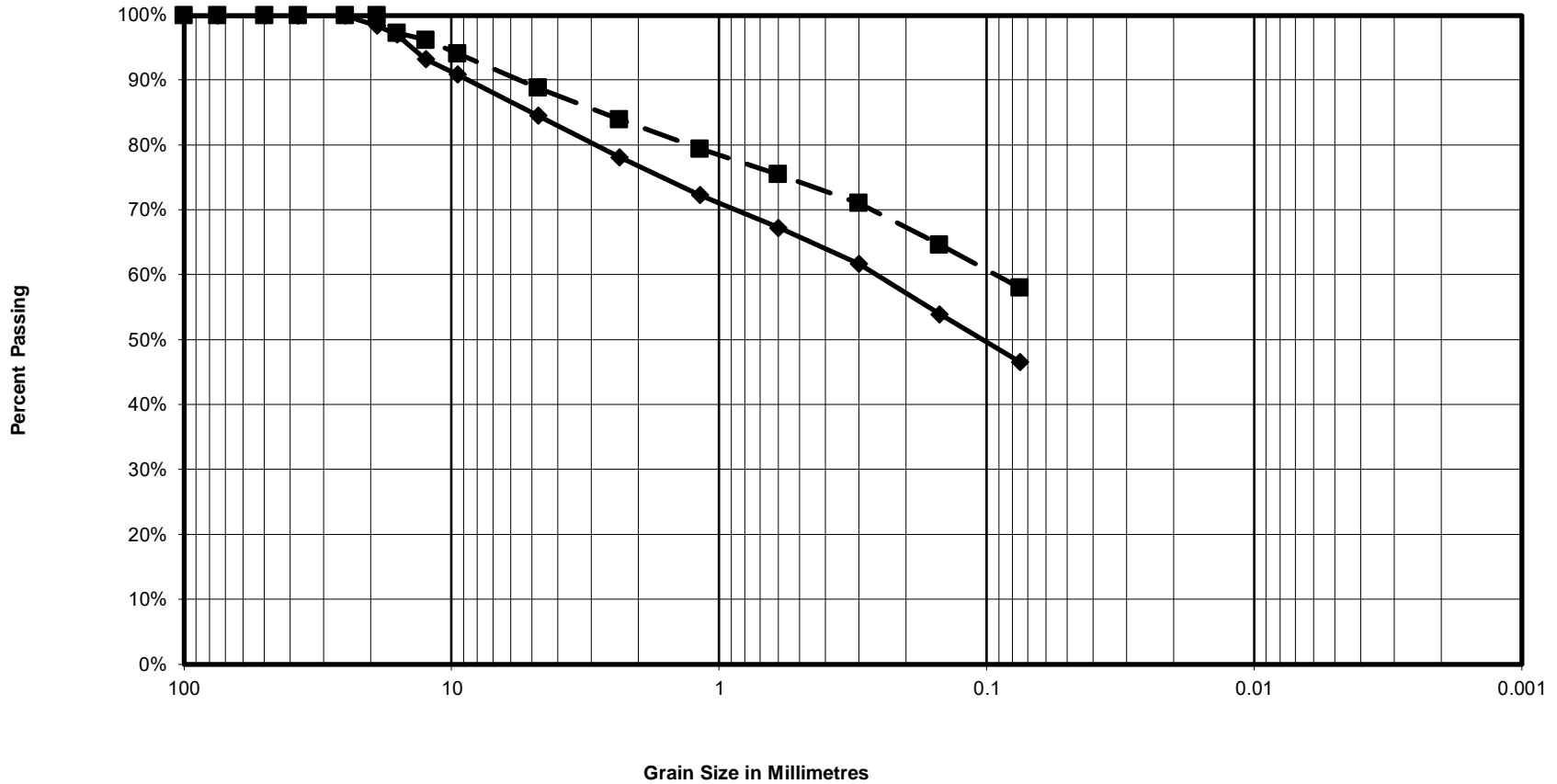

Gravel		Sand			Silt and Clay
Coarse	Fine	Coarse	Medium	Fine	

Unified Soil Classification System ASTM D 2487/2488

Curve	BOREHOLE/TESTPIT	LAB SAMPLE NUMBE	DEPTH (m)	Soil Fractions			Soil Description
				Gravel	Sand	Silt/Clay	
—	TP2A-BS3	S21-008	4.0m	15%	38%	47%	clayey sand (SC) with gravel TILL
- - -	TP6A-BS2	S21-008	4.7m	11%	31%	58%	sandy lean clay (CL) TILL

# PLASTICITY CHART

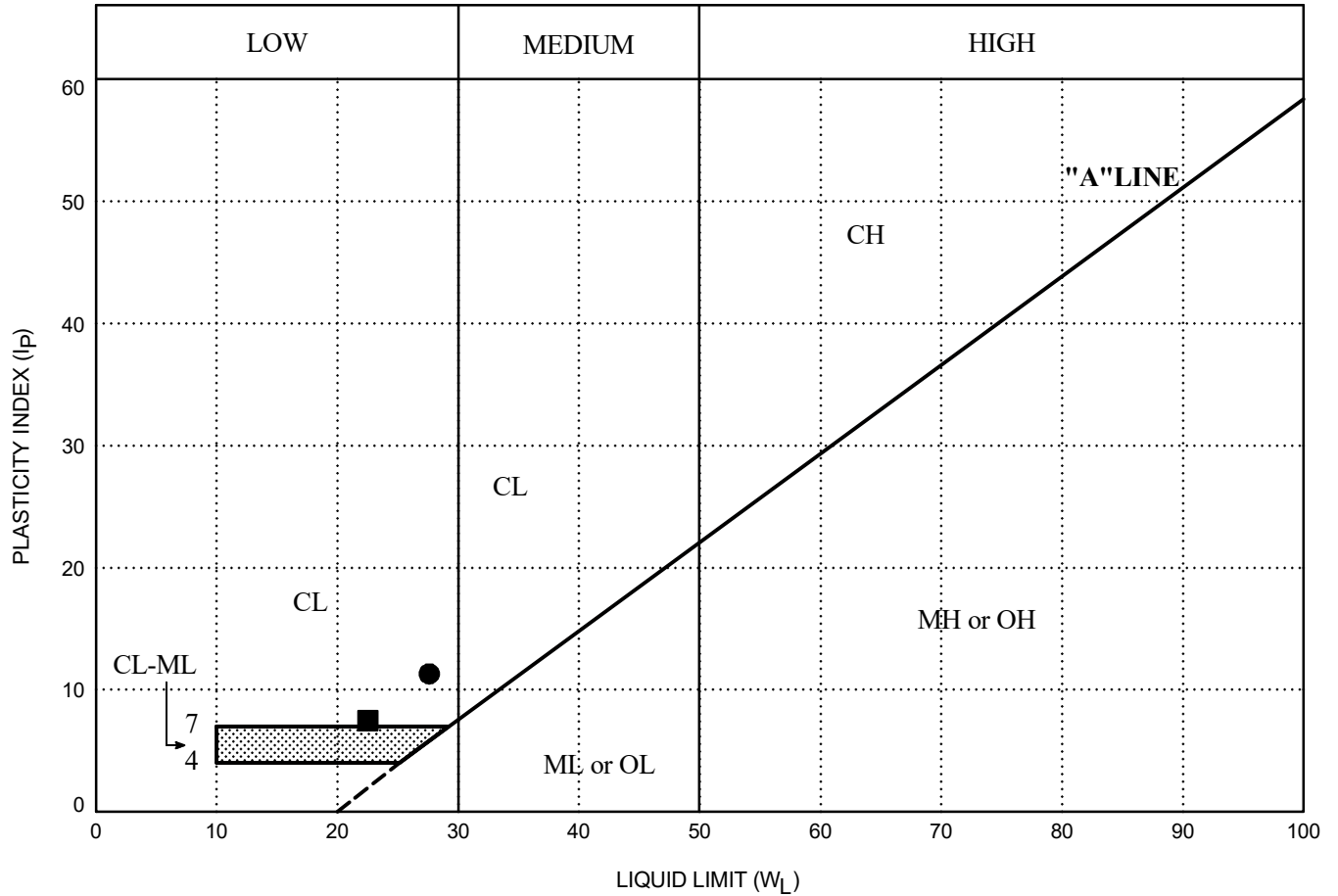

SYM.	SOURCE	DEPTH (m)	LL	PL	PI	W%	DESCRIPTION
●	TP2A	4.0	27.6	16.3	11.3	13.1	clayey sand (SC) with gravel TILL
■	TP6A	4.7	22.5	15.0	7.5	11.7	sandy lean clay (CL) TILL

	Project: <b>WRSR - TOUQUOY GOLD MINE</b>	Location: <b>MOOSE RIVER, NOVA SCOTIA</b>
	Job No.: <b>121619250</b>	Notes:
	Date: <b>2021/02/23</b>	<b>SOIL PLASTICITY</b>